



SNOCROSS

OPERATOR'S MANUAL

040-00032-01

SNOCROSS MOTION OPERATOR'S MANUAL

Safety

OPERATION

Before operating game, read this manual. Failure to properly install and operate this game could result in malfunction or accident. Operate the game in accordance with the manual.

TRANSPORTING

The cabinet is very heavy. Because the monitor is high, the cabinet is also very top-heavy. Use appropriate care when moving or transporting cabinet. It contains fragile glass and electronic components. Avoid rough handling.

HANDLING COMPONENTS

Many components are extremely sensitive to handling, environmental and Electrostatic Discharge (ESD) events—especially the computer. Do not handle it roughly. Before servicing, call your distributor and inquire about the PC warranty. Use proper ESD procedures when servicing. Protect components from harmful environmental conditions, such as extreme temperatures, excessive moisture or other damaging effects.

DISCONNECT POWER

Always turn the power off and unplug the unit before servicing or making adjustments unless otherwise instructed. Installing or repairing components while power is on can damage the components and void the warranty.

GROUNDING

Avoid electrical shock. Do not plug in AC power until you have inspected and properly grounded the unit. Only plug into a grounded, three-wire outlet. Do not use a “cheater” plug or cut off the ground pin on the line cord.

ELECTRICAL SHOCKS

There is no isolation transformer in the cabinet. Disconnect AC power before servicing. However, be aware that lethal voltages can remain in the electronic components even when AC power is disconnected. Use extreme caution when servicing. Verify that there is a working ground connection. If the unit sustains water damage, cease using it immediately and unplug AC power.

MONITOR

The monitor contains no user serviceable parts. Do not attempt to service the monitor.

POWER SELECTOR

Before installing game, ensure the voltage on the PC is set properly. There is a 115/230 VAC selector switch that must be set for the correct voltage for your site. Verify the fluorescent lamp rating. The rating must match the line voltage at the installation site.

POWER CORD

If the power cord is damaged or lost, replace it with an identical cord as supplied by the manufacturer or an authorized service agent.

SURGE SUPPRESSOR

It is recommended that you plug your game's power cord into a surge suppressor to help protect from power surges that may damage sensitive electronic components.

SNOCROSS MOTION OPERATOR'S MANUAL

Service Manual

CONNECTORS

When servicing machine, ensure all connectors mate properly. If connectors do not slip in easily, do not force them. Connectors are often keyed and only connect one way. Check for correct orientation.

COMPUTER

The computer contains sensitive components, including a hard drive. Do not handle it roughly. Call your distributor before servicing its internal components. Ask about warranty information as it relates to the PC.

Do not turn the PC power switch on or off. It should remain permanently in the ON position.

Cycle AC power on or off with the cabinet power switch.

A dongle has been inserted into one of the USB ports. This is required for game play.

Do not remove the dongle except for troubleshooting purposes.

FLUORESCENT LAMP

A dropped fluorescent lamp tube may break and implode. Shattered glass from the implosion can travel long distances and cause bodily injury. Use proper procedures when handling broken materials, as these items can contain **hazardous material such as mercury or lead.**

HAZARD TO EPILEPTICS

A small portion of the population has an epileptic condition that may cause seizures. Affected persons experience seizure while watching some television pictures or playing certain video games. People who have not had seizures may still have an undetected epileptic condition. If anyone in your family has experienced epilepsy symptoms (seizures or loss of awareness), consult your physical before using video games. While children play video games, a parent should observe. Be alert to the following symptoms: dizziness, altered vision, eye or muscle twitching, involuntary movements, loss of awareness, disorientation or convulsions. If you or your child experiences these symptoms, discontinue use immediately and consult your physician.

MANUAL

Keep this manual available and ready for use. If the game fails to function properly, turn off the machine and unplug the AC line cord. Contact your local distributor. Your warranty, when applicable, lasts 60 days from your purchase date. You may not reproduce this document or any of its contents without written authorization from Raw Thrills, Inc. .

SPECIFICATIONS

For reasons such as performance, this product's specifications may change without notice. Federal patent, copyright and other intellectual property laws protect the content, devices and design of the game and its equipment.

Product Specifications

Electrical Power

United States, International and Japan

Inrush AC Current: 7 Amps

Operating AC Current: 5 Amps

Voltage: 115 VAC

Temperature

50° F to 104° F

(10° C to 40° C)

Humidity

Must not exceed 95% relative humidity

Dimensions

Height: 81" (2.06 meters)

Width: 39" (.99 meters)

Depth: 55" (1.39 meters)

Carton Weight

405 lbs. (184 kg)

Setup

Unpack Materials

1. Place the shipping crates on a flat, stable surface.
2. Cut the banding straps and remove the cardboard lids.
3. Lift off the large cardboard containers surrounding the front pedestal and monitor assemblies and remove any shipping cleats.
4. Remove the coin door key from the coin return slot.
5. Open the top coin door.
6. Locate the keys for the back door and the cash box door.
7. Open the cash box door and remove the cash box.
8. Check for shipping damage to the following:
 - SnoCross player accessible areas such as the sled, control panel and dash.
 - Marquee and monitor
 - Cabinet decals
9. Check the AC line cord for visible signs of damage.
Pay particular attention to the plug and line cord insulation.

Check Electrical Settings

1. Verify the voltage in the nearest AC outlet.
2. Verify the AC outlet ground connection is present and working.
3. Open the back door of the monitor assembly.
4. Near the AC power transformer, verify the voltage selector switch is set to correct AC voltage.
5. Route the line cord so that the plug is near the AC outlet.
6. Replace the back door of the monitor assembly.

Game Power Up

1. Plug in line cord to AC outlet.
2. Turn the power switch to ON.
3. Check that no component is excessively hot or emitting foul odors.
If not, turn off AC power and disconnect line cord. Refer to the diagnostic section of this manual.
4. Once software loads, you will be asked to calibrate the controls.
If not, enter the service menu by pressing the TEST button located on the bracket inside the top coin door.

SNOCROSS MOTION OPERATOR'S MANUAL

Diagnostics and Adjustments

The Service Button Panel has four buttons, three of which can navigate the menu system.
But it is easiest to navigate with a Start, View & SnoBall button

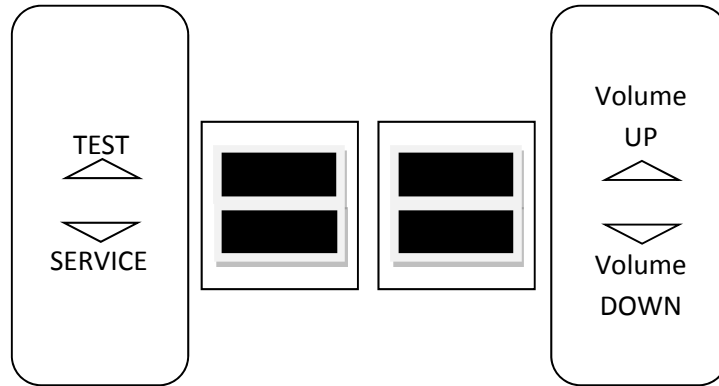

- Service Panel TEST enters diagnostic system.
- Either Service Panel TEST button or Start button selects the highlighted option.
- Service Panel VOL DOWN button or SnoBall button moves down through menu or setting choices.
- Service Panel VOL UP button or pressing View moves up through menu or setting choices.
- Highlight and select Exit to return to previous screen.

An on-screen message acknowledges changes or when you exit a selection without making a change.

At the bottom of each screen there is a brief description of the menu option's function. A complete description is available here for all menu functions.

Instructions for completing your first calibration start on the next page.

INITIAL GAME SETUP

GAME CONTROLS CALIBRATION

1. If the calibration screen is not visible, press the TEST button to enter the Diagnostic System.
2. From the Main Menu, use Volume +/- to highlight Calibration.
3. Press a Start button to enter calibration.

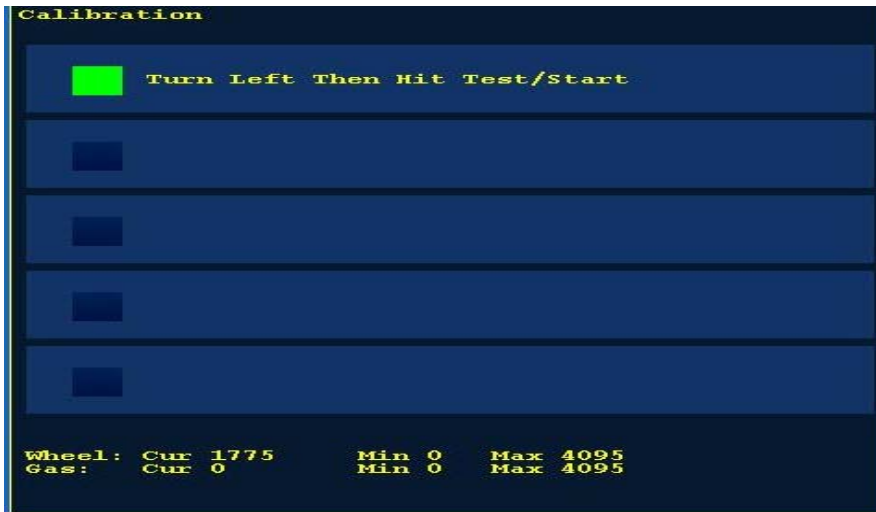

4. Follow on-screen instructions. Re-try if calibration data is not valid.
5. Game will proceed to Location and Venue Name entry.
6. Enter information to be displayed when player scans the QR Code.
7. Game will enter Attract Mode. All game settings will be default values if no changes are made at this time.

GAME CONTROLS AND INTERFACE INSPECTION

Other Tests

See the Diagnostic Section for further information.

1. Enter the Switch Test menu and verify all switches function.
2. Enter the Screen Test menu and verify that video is acceptable.
3. Enter the Sound Test menu and verify the audio works and is not distorted.
4. Enter the Coin Meter Test menu and verify the operation of the coin meter.
5. Enter the Cabinet Lamps Test menu and verify that all cabinet lights work correctly.
6. Enter the Watchdog Test menu, which reboots the game.
7. Upon a successful reboot, you are ready to make adjustments to pricing, volume and other functions found in the Adjustments, Audits and Diagnostics section.

Adjustments, Audits and Diagnostics

Main Menu

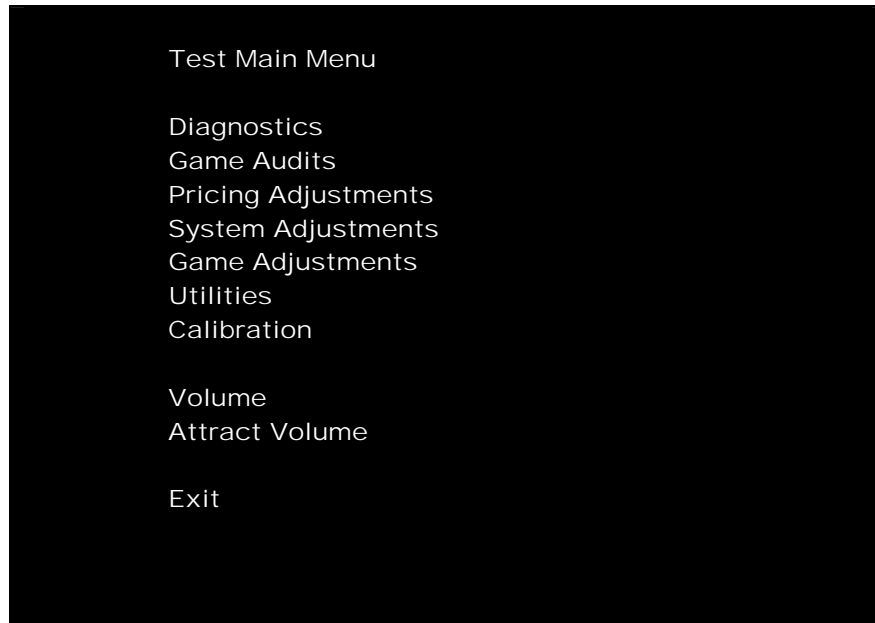

Menu Option	Description
Diagnostics	Verify all game functionality. Allows activation of all inputs and outputs, including linking and watchdog test.
Game Audits	View game earnings and gameplay statistics.
Pricing Adjustments	Setting for coinage unit, denomination and game pricing.
System Adjustments	System related changes such as networking, language, attract volume, Wheel power, blower and shaker force etc.
Game Adjustments	Game specific adjustments such as difficulty, bonus time, game entry.
Utilities	Clear Credits, Audits and reset player/game statistics. Check system software errors and download data to USB external storage device.

SNOCROSS MOTION OPERATOR'S MANUAL

Calibration	Calibrate controls for maximum player control and game experience.
Volume	Set volume during game only. Attract volume is adjusted independently.
Attract Volume	Set attract/ standby mode volume only.

Main Menu

Diagnostics

Switch Test

For troubleshooting purposes, this menu gives you visual feedback of all switch functions.

Switch Test (Version Build Sep 13 2012:13:08:23)

Wheel/Pedals	Value	Min	Max
Input Device			
Wheel	00.44	0	4095
Gas		0	4095

Buttons	Test/Volume	Keypad
VIEW <input type="checkbox"/>	TEST <input type="checkbox"/>	1 <input type="checkbox"/>
SNOBALL <input type="checkbox"/>	VOL + <input type="checkbox"/>	2 <input type="checkbox"/>
START <input type="checkbox"/>	SERVICE <input type="checkbox"/>	3 <input type="checkbox"/>
COIN 1 <input type="checkbox"/>	VOL - <input type="checkbox"/>	4 <input type="checkbox"/>
COIN 2 <input type="checkbox"/>		5 <input type="checkbox"/>
BILL <input type="checkbox"/>		6 <input type="checkbox"/>
		7 <input type="checkbox"/>
		8 <input type="checkbox"/>
		9 <input type="checkbox"/>
		* <input type="checkbox"/>
		0 <input type="checkbox"/>
		# <input type="checkbox"/>

Version:
 Build Sep 13 2012:13:08:23
 OS Ver:
 Build Sep 13 2012:13:08:23
 Date: Sep 13 2012
 Time: 11:57:38
 ID: 3

Hold View for Lights
 Hold Service Or
 SnoBall To Exit

SNOCROSS MOTION OPERATOR'S MANUAL

Main Menu
Diagnostics
Sound Test

For troubleshooting purposes, this menu gives game sound feedback.

Menu Option	Description
Change Music	Change current music.
Change Effect	Change sound current sound effect.
Play 100Hz or 1kHz	Play low and high frequency to stimulate bass or full range speaker response.
Pan Center, Left, Right	Isolate sound into separate channel to verify correct speaker function.

Main Menu
Diagnostics
Wheel Test

For troubleshooting purposes, this menu allows the wheel force feedback to be activated in left and right direction.

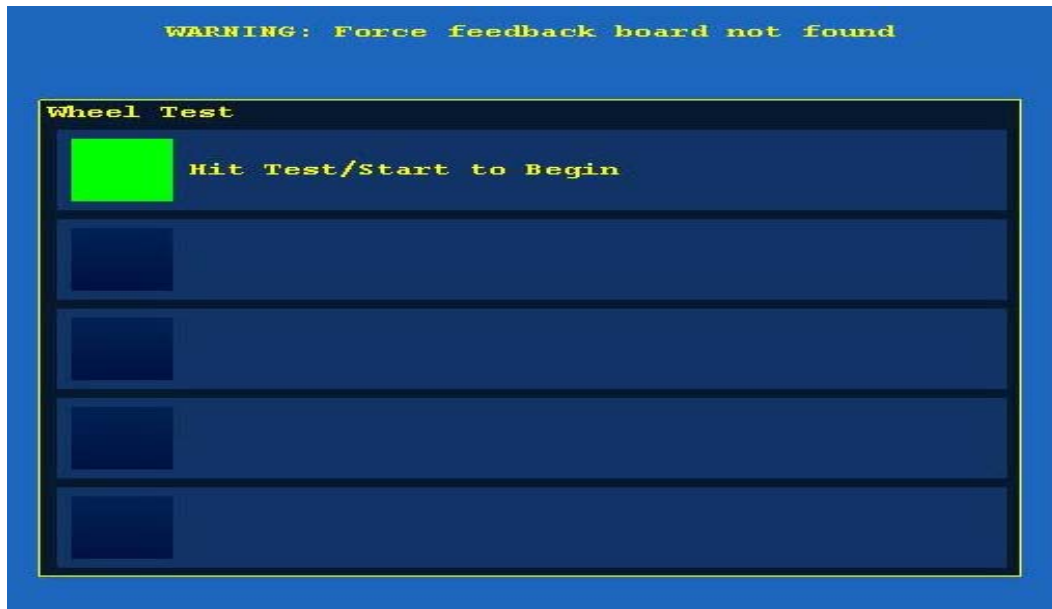

SNOCROSS MOTION OPERATOR'S MANUAL

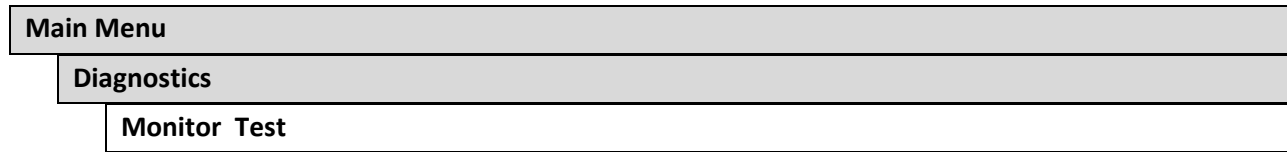

For troubleshooting purposes, this menu allows the diagnosis of the display to detect color or linearity issues.

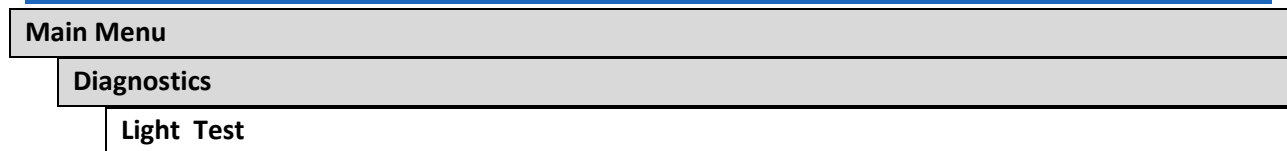
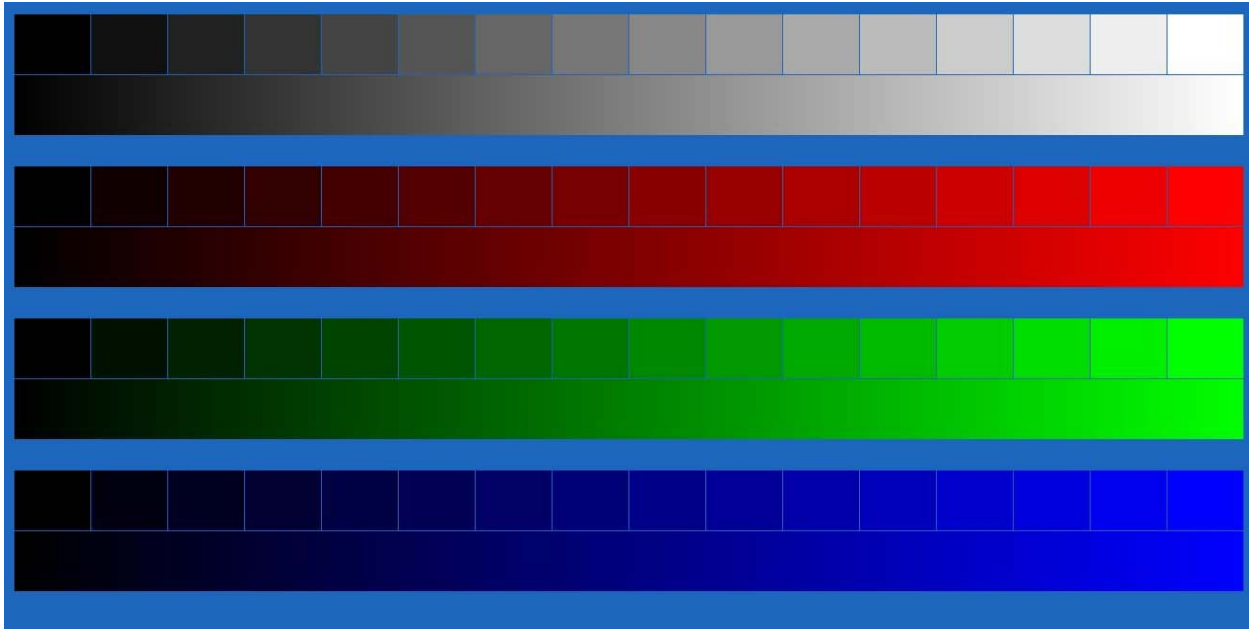

For troubleshooting purposes, this menu allows the diagnosis of the game's controlled lighting features.



SNOCROSS MOTION OPERATOR'S MANUAL

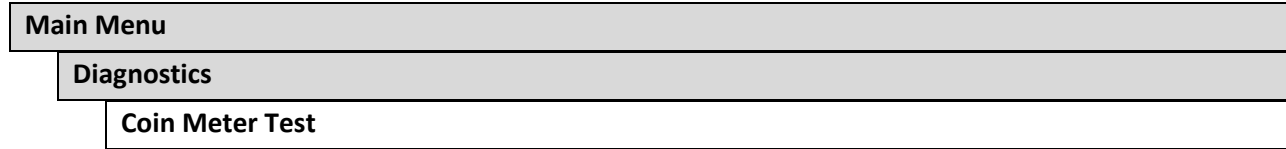

For troubleshooting purposes, this menu allows the activation of coin meter. Press Start or Test to advance coin meter.

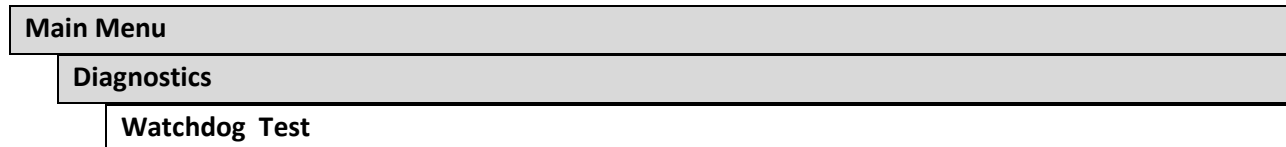

This menu allows the activation of the watchdog/reset system. Press Start or Test to start test. The game's watchdog system allows the machine to recover automatically from a crash or a failure to boot. The watchdog system is always active.



This allows the operator to view and reset the link status of two or more games connected to a single network. Linking three or more games requires a network hub and must be purchased separately.

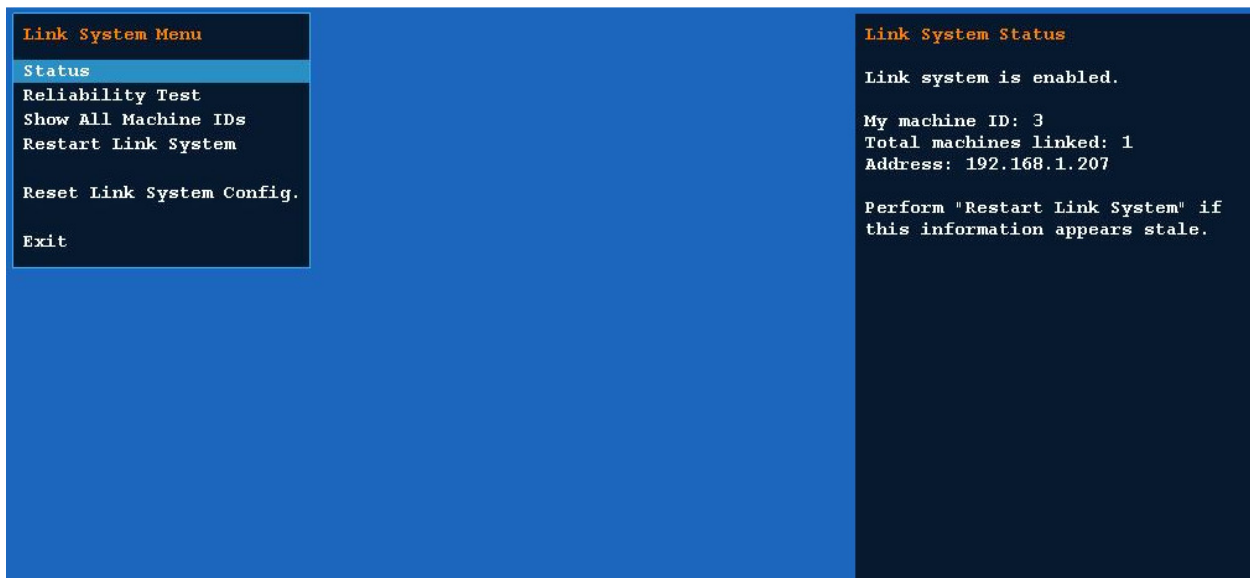

SNOCROSS MOTION OPERATOR'S MANUAL

Main Menu

Diagnostics

Blower Test

Test the blower function at different speeds. This can also be used to determine desired blower intensity.

Main Menu

Diagnostics

Shaker Test

Test the seat shaker function at different levels. This can also be used to determine desired shaker intensity for maximum player experience.

Main Menu

Game Audits

General Audits 1

View general game statistics.

```
General Audits
Time Since Boot          2:00.55
Time Game On            541:09:2.50
Time Game Played        122:11:23.53
Time Per Game           2:13.78

Games Played            3288
Games Started           2442
Games Continued         270
Games Timed Out         32
Free Games              426      12.96%
Pin Games               7        0.21%
Link Games              7        0.21%

Boot Ups                471
Test Mode Entries       87
Maintenance Reboots    0
Watchdog Resets         0
No I/O Board Init      0
Unfinished Games       0

I/O Lost                0
I/O Recovered           0
Dongle Lost            0
Dongle Recovered       0
Prefs Repaired         0
Prefs Damaged          0
```

SNOCROSS MOTION OPERATOR'S MANUAL

Main Menu

Game Audits

General Audits 2

General Audits

```
First Person Time           1:40.52
Dynamic Cam Time           94:10:39.00

Total Coindrops             13011
Slot 0 Left                 13011
Slot 1 Right                 0
Slot 2 DBV                   0

Bonus Credits               0

Current Credits             0
Current Coins                0
```

Main Menu

Game Audits

Courses

Audits Menu

General 1
General 2
Courses
Course Wins
Placings
Vehicles
Upgrades
Music
Stunts
Exit

Track	Count	Percent
MOSCOW	335	10.74%
ALASKA	387	12.41%
ANTARCTICA	426	13.66%
COLORADO	510	16.35%
WASHINGTON D.C.	590	18.92%
FRANCE	434	13.91%
CHINA	437	14.01%

SNOCROSS MOTION OPERATOR'S MANUAL

Main Menu

Game Audits

Courses Wins

Audits Menu	Track	Wins	Percent
General 1	MOSCOW	26	7.76%
General 2	ALASKA	23	5.94%
Courses	ANTARCTICA	72	16.90%
Course Wins	COLORADO	117	22.94%
Placings	WASHINGTON D.C.	82	13.90%
Vehicles	FRANCE	107	24.65%
Upgrades	CHINA	0	0.00%
Music			
Stunts			
Exit			

Main Menu

Game Audits

Placing

Audits Menu	Place	Count	Percent
General 1	1st Place	427	13.77%
General 2	2nd Place	1137	36.65%
Courses	3rd Place	1080	34.82%
Course Wins	4th Place	389	12.54%
Placings	5th Place	8	0.26%
Vehicles	6th Place	2	0.06%
Upgrades	7th Place	6	0.19%
Music	8th Place	15	0.48%
Stunts	9th Place	2	0.06%
Exit	10th Place	3	0.10%
	11th Place	3	0.10%
	12th Place	30	0.97%
	Average Place	2.63	
	Max Win Streak	2	
	Max Lose Streak	4	
	Cur Win Streak	0	
	Cur Lose Streak	0	

SNOCROSS MOTION OPERATOR'S MANUAL

Main Menu

Game Audits

Vehicles

Audits Menu		Vehicle	Count	Percent
General 1		Snowmobile1	562	18.02%
General 2		Snowmobile2	336	10.77%
Courses		Snowmobile3	638	20.46%
Course Wins		Snowmobile4	547	17.54%
Placings		Snowmobile5	408	13.08%
Vehicles		Snowmobile6	628	20.13%
Upgrades				
Music				
Stunts				
Exit				

Main Menu

Game Audits

Upgrades

Audits Menu		Upgrade	Count	Percent
General 1		Decal	652	
General 2		Handling	622	
Courses		Neon	538	
Course Wins		Bodykit	685	
Placings		Engine	623	
Vehicles		Upgrade Users	6	
Upgrades		Upgrade Buy-Ins	0	
Music		Upgrade Credits	6	
Stunts		1 visit:	4	66.67%
Exit		2 - 4 visits:	2	33.33%
		5 - 9 visits:	0	0.00%
		10 - 14 visits:	0	0.00%
		15 - 19 visits:	0	0.00%
		20 - 24 visits:	0	0.00%
		25 - 29 visits:	0	0.00%
		30 - 39 visits:	0	0.00%
		40 - 49 visits:	0	0.00%
		50 - 69 visits:	0	0.00%
		70 - 99 visits:	0	0.00%
		100+ visits:	0	0.00%

SNOCROSS MOTION OPERATOR'S MANUAL

Main Menu
Game Audits
Music

Audits Menu	Tune	Time
General 1	Antarctica	13:12:21.75
General 2	Moscow	10:11:36.90
Courses	DC	17:37:24.17
Course Wins	Colorado	14:08:24.79
Placings	France	13:27:6.95
Vehicles	China	13:47:44.64
Upgrades	Alaska	11:47:50.87
Music		
Stunts		
Exit		

Main Menu
Game Audits
Stunts

Audits Menu	Trick	Count
General 1	Wheelies	7100
General 2	Total Nitros used	9009
Courses	At least one Nitro	14
Course Wins		
Placings	Start Autopilots	57
Vehicles	Race Autopilots	35
Upgrades		
Music		
Stunts		
Exit		

SNOCROSS MOTION OPERATOR'S MANUAL

Main Menu

Pricing Adjustments

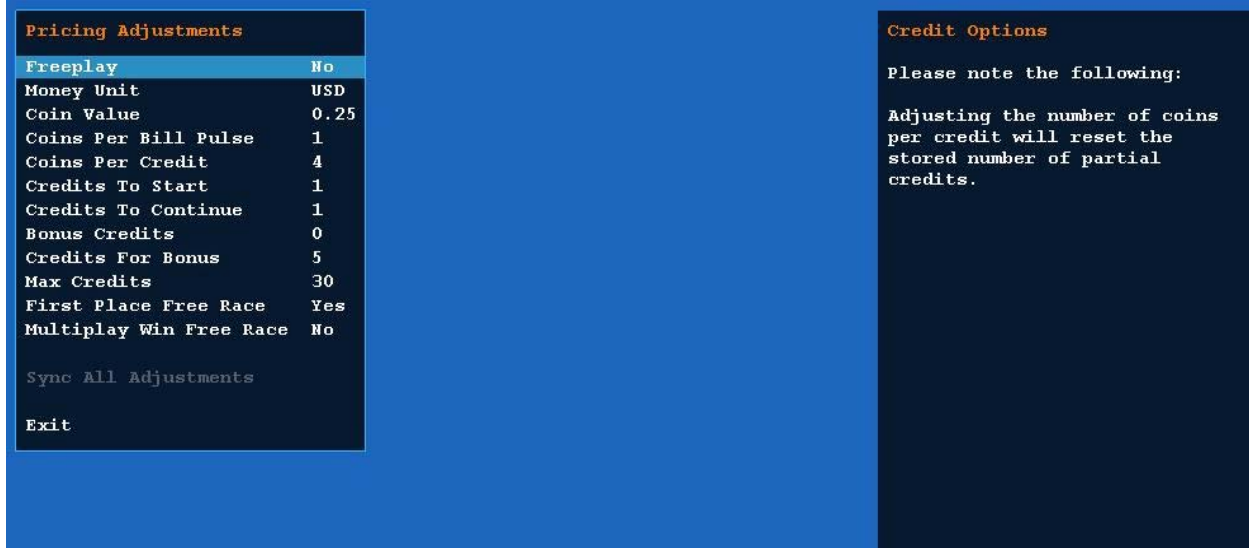

Settings, Defaults and Choices

Setting	Default	Choices
Freeplay	No	Yes/No
Money Unit	USD	Card Swipes, USD, AUD, CAD, EUR, GBP,DEM,FRF,JPY,NLG,ITL,CHF,DKK,MXN,RUR,KRW,CNY
Coin Value	0.25	0.01, 0.05, 0.10, 0.25, 0.50, 1.00, 2.00, 5.00, 10.00, 20.00, 50.00, 100.00, 500.00, 1000.00, 10000.00
Coins per Bill Pulse	1	1, 2, 3, 4, 5, 10, 20, 25, 50, 100
Coins Per Credit	4	1-10
Credits To Start	1	1-10
Credits To Continue	1	1-10
Bonus Credits	0	Options: 0-10
Credits For Bonus	5	1-20
Max Credits	30	10, 15, 20, 25, 30, 35, 40, 45, 50
First Place Free Race	Yes	Yes/No
Multiplay Win Free Race	No	Yes/No

SNOCROSS MOTION OPERATOR'S MANUAL

Main Menu

System Adjustments

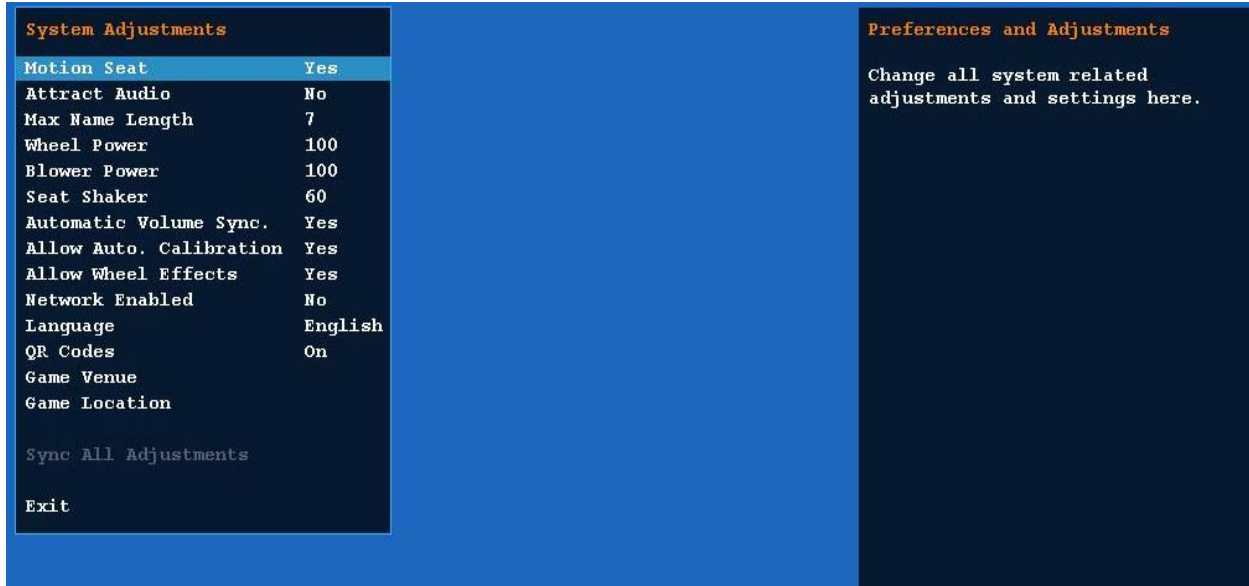

Settings, Defaults and Choices

Setting	Default	Choices
Motion Seat	Yes	Yes, No
Checkpoint Time Bonus	No	Yes, No
Max Name Length	7	3, 4, 5, 6, 7
Wheel Power	100	0-100
Blower Power	100	0-100
Seat Shaker	60	0-100
Automatic Volume Sync	Yes	Yes, No
Allow Auto Calibration	Yes	Yes, No
Allow Wheel Effects	Yes	Yes, No
Network Enabled	No	Yes, No
Language	English	English, Russian, Chinese, Japanese
QR Codes	On	On, Off
Game Venue	None	Enter Venue Name to be displayed.
Game Location	None	Enter Location Name to be displayed.

SNOCROSS MOTION OPERATOR'S MANUAL

Main Menu

Game Adjustments

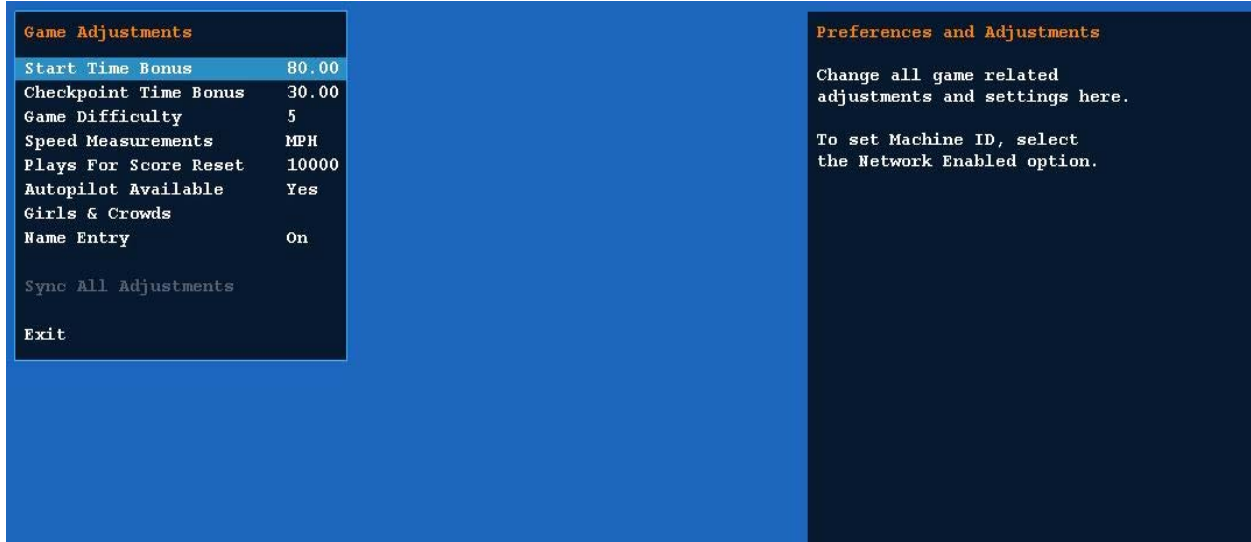

Settings, Defaults and Choices

Setting	Default	Choices
Start Time Bonus	80	30-120
Checkpoint Time Bonus	30	10-100
Game Difficulty	5	1-10
Speed Measurements	MPH	MPH, KPH
Plays For Score Reset	10000	1000-20000
Autopilot Available	Yes	Yes, No
Girls(Racer/ Crowds)	Yes	Yes, No
Name Entry	On	On, Off

SNOCROSS MOTION OPERATOR'S MANUAL

Main Menu

Utilities

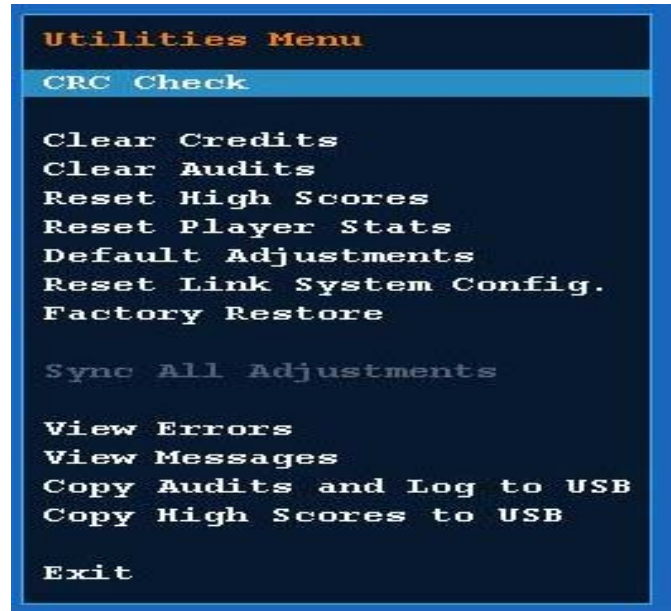

Main Menu

Calibration

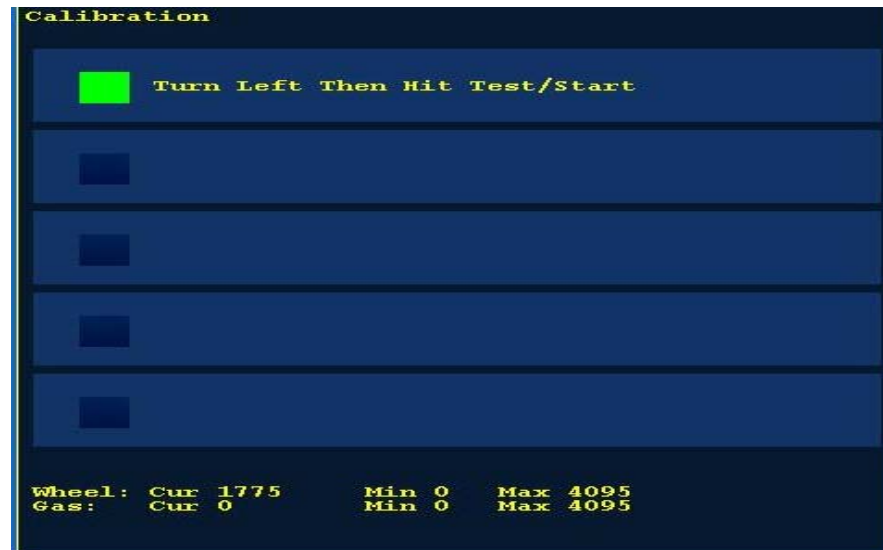

SNOCROSS MOTION OPERATOR'S MANUAL

Main Menu

Game Volume

Adjust game volume during play mode only. Attract volume is adjusted separately. Automatic Volume Synch allows for all linked units to be adjusted simultaneously.

Main Menu

Attract Volume

Adjust attract or standby volume only.

Maintenance

Hard Drive Recovery

Symptoms requiring hard drive recovery include

- File Test reports bad or missing files.
- Game fails to finish loading during startup.
- After resetting the AC power, an error is reported.
- You are prompted to insert a boot DVD.
- Erratic Game or Attract Mode.
- Garbled characters
- Bad audit files

To identify corrupt files, press Test, choose System Test Menu and run the CRC Check.

The only way to repair corrupt files is to recover the hard drive, as detailed below.

COMPUTER

The computer contains sensitive components, including a hard drive. Do not handle roughly. Call your distributor before servicing its internal components. Ask about warranty information as it relates to the PC.

Do **not** use the PC on/off switch. Turn AC power on or off with the cabinet power switch.

1. With game and PC on, verify that the RIO board has power. If not, see Troubleshooting.
2. Open the Coin door.
3. Open the PC DVD-ROM tray by reaching back to the PC and pressing the Open/Close button on the drive bay.
4. Insert the first of two restore DVDs (labeled *Disc 1*) into the tray.
5. Close the tray by pressing the Open/Close button again.
6. Turn cabinet power switch to OFF. Wait 30 seconds.
7. Turn cabinet power switch to ON.
8. Recovery begins automatically when PC boots up.
9. If recovery does not begin, check to ensure disc is inserted correctly and is not damaged.
10. Initial software loading may take several minutes. Check progress periodically.
Do not interrupt power or reset the game during recovery.
11. When software has been loaded, a message indicates that restore is complete. When instructed to remove disc, open DVD-ROM drive tray and remove disc.
12. Turn cabinet power switch off.
13. **After 30 seconds, turn cabinet power switch on.**
14. Game will reboot and enter calibration mode.
15. Re-calibrate controls.

BIOS Settings/Power Management

NOTICE

The PC ships with correct BIOS settings. Making changes to the BIOS different from the description below may adversely affect game functions.

This BIOS setting lets the PC automatically power up. With the setting enabled, the PC reboots when it detects AC power. This eliminates the need to manually turn the PC back on after power disruption.

Do **not** use the PC on/off switch. Turn AC power on or off with the cabinet power switch.

1. Turn cabinet power switch off.
2. Open rear of cabinet.
3. Connect a USB keyboard to the PC.
4. While holding the F10 key on the keyboard down, turn cabinet power switch on.
5. When the BIOS menu screen appears, make the following adjustments.

(SETTINGS BELOW ARE SPECIFIC TO HP6005 PC. PLEASE CHECK RAWTHRILLS.COM FOR LATEST INFORMATION ON BIOS SETTINGS AND OTHER TECHNICAL UPDATES)

STORAGE => Storage Options => SATA Emulation : "Native Mode IDE"

ADVANCED => Power On Options => After Power Loss : "On"

6. Follow instructions on screen to save and exit.
7. PC will reset and load the game.

MECHANICAL ILLUSTRATIONS
AND
ELECTRICAL SYSTEM DIAGRAM

ITEM NO.	PART NUMBER	DESCRIPTION	QTY.
1	SnoMotion LCD Cabinet Assembly	SnoMotion LCD Cabinet Assembly	1
2	SnoBike T-Base Assembly	SnoBike T-Base Assembly	1
3	SnoMotion Snowmobile Assembly	SnoMotion Snowmobile Assembly	1
4	SX42 Marquee Assembly	SX 42" Marquee Assembly	1
5	96075A223 (McMaster-Carr)	Alloy STL Pin-in-Torx Button Socket Cap Screw 1/4"-20 Thread, 1" Length, Black	8
6	LW (.25 in)	Split Lock Washer, 1/4" Screw	8
7	FW (.25 in)	Flat Washer, 1/4" Screw, Black	8
8	96075A195 (McMaster-Carr)	Alloy STL Pin-in-Torx Button Socket Cap Screw 10-32 Thread, 1" Length, Black	2
9	LW (.190 in)	Split Lock Washer, #10 Screw	2
10	FW (.190 in)	Flat Washer, #10 Screw, Black	2

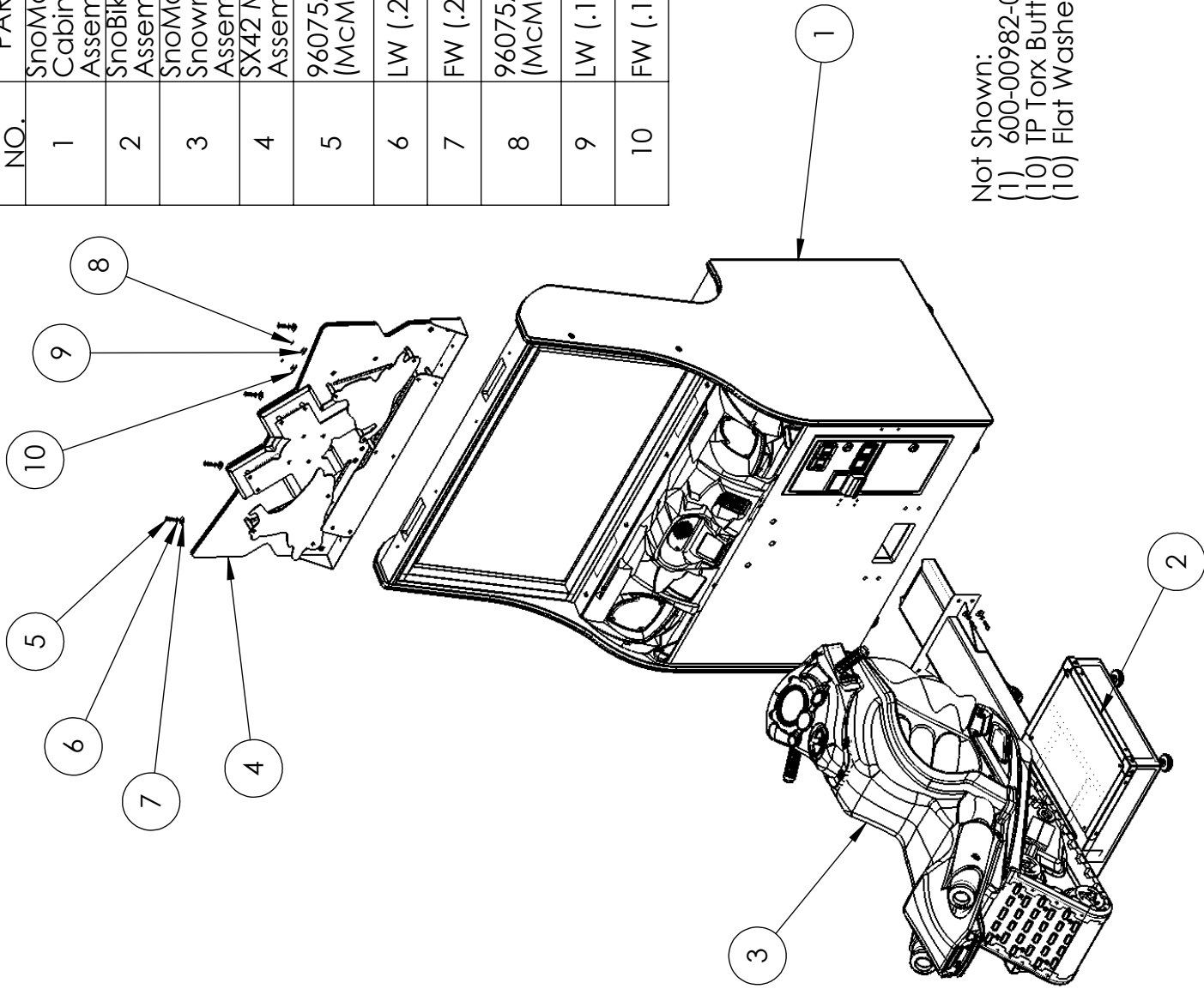

Not Shown:

- (1) 600-00982-01 - Rubber Swivel Guard
- (10) TP Torx Button Head Machine Screws (10-32 x 1.25"), Black
- (10) Flat Washers, #10 Screw, Black



SnoCross Motion Final Assembly

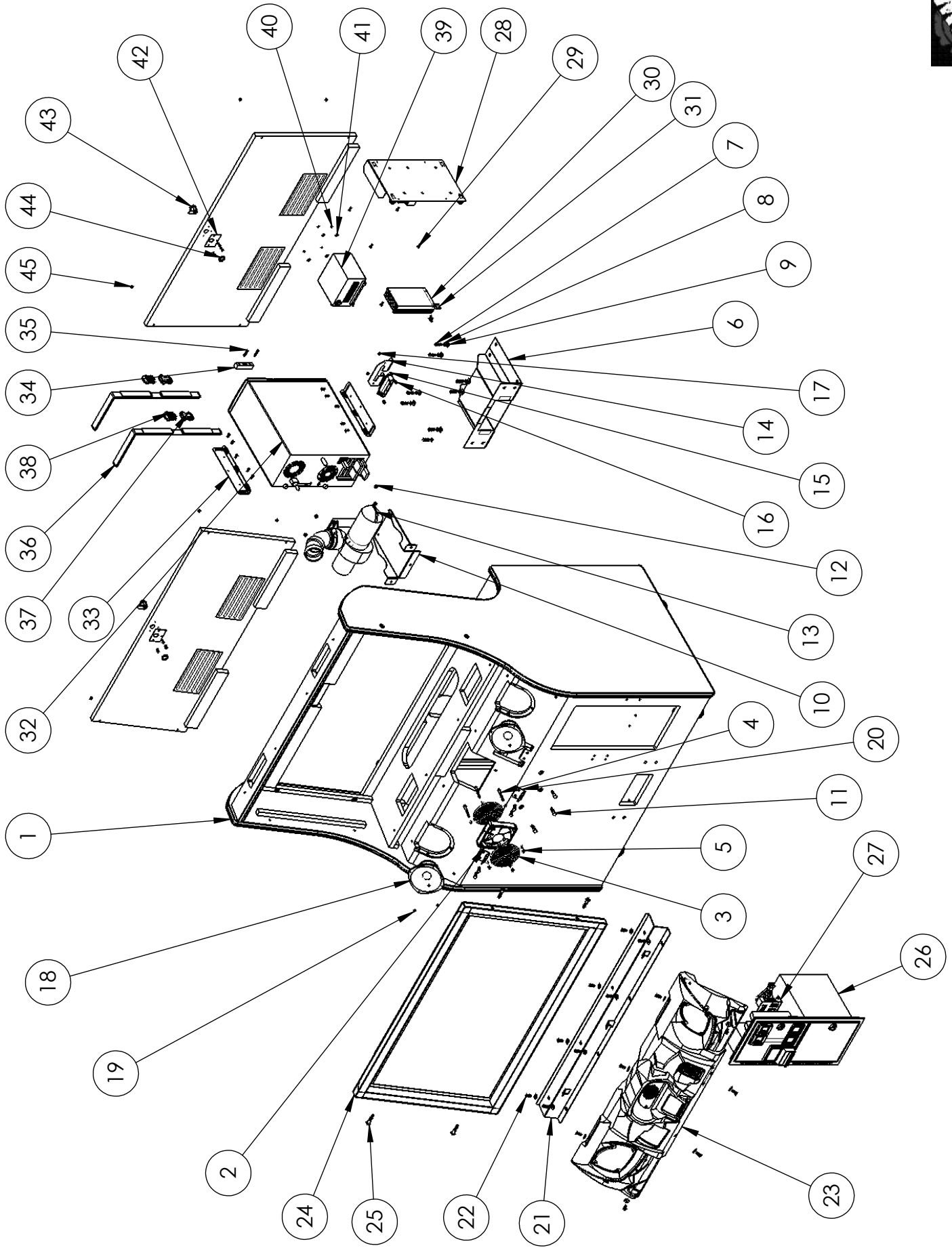

SnoMotion LCD Cabinet Assembly
(BOM on next page)

SnoMotion LCD Cabinet Assembly BOM

ITEM NO.	PART NUMBER	DESCRIPTION	QTY.
1	601-00590-01	SX Motion - 42" LCD Cabinet	1
2	820-00012-00	Cooling Fan(standard size): 12VDC, 3W, 80CFM	1
3	800-00001-00	120mm Wire Fan Guard	2
4	91772A206 (McMaster-Carr)	18-8 SS Pan Head Phillips Machine Screw 8-32 Thread, 2-1/4" Length	4
5	90631A009 (McMaster-Carr)	Znc-Pltd Grade 2 STL Nylon-Insert Hex Locknut 8-32 Thread Size, 11/32" Width, 15/64" Height	4
6	600-00500-01	SB2 - Inner Tunnel Support Bracket	1
7	92865A542 (McMaster-Carr)	Grade 5 Zinc-Plated Steel Hex Head Cap Screw 1/4"-20 Thread, 1" Long, Fully Threaded	16
8	LW (.25 in)	Split Lock Washer, 1/4" Screw, Black	8
9	FW (.25 in)	Flat Washer, 1/4" Screw, Black	23
10	600-00963-01	Mounting Shelf - Blower Assembly	1
11	93548A544 (McMaster-Carr)	Grade 2 Round Head Square Neck Bolt Zinc-Plated Steel, 1/4"-20 Thread, 1-1/4" Length, Black	3
12	90675A029 (McMaster-Carr)	Znc-Pltd STL Machine Screw Nut W/Tooth Washer 1/4"-20 Thrd Sz, 7/16" Nut Width, 3/16" Nut Height	7
13	Blower Mounting Assembly	Blower Mounting Assembly	1
14	600-00254-01	Blind Mate Bracket - Female	1
15	213974-1	Blind Mate Housing (Female): 5mm (.197") Centerline, 600 V, 14 A max. (AMP)	1
16	90316A194 (McMaster-Carr)	18-8 SS Hex Washer Head Slotted Machine Screw 8-32 Thread, 1/2" Length	2
17	90675A009 (McMaster-Carr)	Znc-Pltd STL Machine Screw Nut W/Tooth Washer 8-32 Thread Sz, 11/32" Nut Width, 1/8" Nut Height	2
18	2-1-10-00-00-000	Full Range Speaker: 5.25", 8 Ohm	2
19	90316A197 (McMaster-Carr)	18-8 SS Hex Washer Head Slotted Machine Screw 8-32 Thread, 3/4" Length	6
20	600-00961-01	Mounting Bracket - Bottom Dash	2
21	600-00957-01	Mounting Channel - Dash	1
22	96075A219 (McMaster-Carr)	Alloy STL Pin-in-Torx Button Socket Cap Screw 1/4"-20 Thread, 3/4" Length	11
23	SnoMotion Dash Assembly	SnoMotion Dash Assembly	1
24	SnoMotion LCD Assembly	SnoMotion LCD Assembly	1
25	BB142045UHD (Stafast)	Joint Connector Bolt: 1/4"-20 Thread, 1-3/4" Length, Hex Drive 4 mm, Black	4
26	800-00005-01	Mid-Width Coin Door Vault (Happ)	1
27	810-00053-01	Test Service Button Assembly	1
28	RIO Hardware Assembly	RIO Hardware Assembly	1
29	90054A197 (McMaster-Carr)	Znc-Pltd STL Hex Washer Head Sheet Mtl Screw Slotted, NO. 8 Size, 3/4" Length	25
30	2-1-02-00-00-021	U-San UP-52 Power Supply: 12V/9A	1
31	600-00121-01	Bracket - Power Supply Mounting	1
32	HP6005	(or approved equivalent PC)	1
33	600-00901-01	Bracket - PC Strap Mounting	2
34	601-00580-01	PC Wood Cleat	1
35	91675A333 (McMaster-Carr)	Hex Washer Head Screw for Sheet Metal 410 Stainless Steel, NO. 8 Size, 1-1/4" Length	2
36	87425K76 (McMaster-Carr)	PC Mounting Nylon Strip: 0.075" Thick, 1" Width, Black (56" Length)	2
37	29705T86 (McMaster-Carr) - female	Plastic Buckle for Webbing NO Sew Squeeze-Release for 1" Wide Webbing (Female)	2
38	29705T86 (McMaster-Carr) - male	Plastic Buckle for Webbing NO Sew Squeeze-Release for 1" Wide Webbing (Male)	2
39	2-1-02-00-00-017	APS Power Supply (90-AP-188)	1
40	96075A123 (McMaster-Carr)	Alloy STL Pin-in-Torx Button Socket Cap Screw 6-32 Thread, 1" Length, Black	4
41	FW (.138 in)	Flat Washer, #6 Screw, Black	4
42	600-00043-01	Lock Retainer	2
43	150-00001-00	Standard Door Lock	2
44	Hex Nut for Standard Lock Assembly	Hex Nut for 7/8" L Standard Lock	2
45	96075A203 (McMaster-Carr)	Alloy STL Pin-in-Torx Button Socket Cap Screw 10-32 Thread, 1-1/2" Length, Black	8

ITEM NO.	PART NUMBER	DESCRIPTION	QTY.
1	600-00719-01	SX - Blower Bracket	1
2	604-00022-01	Johnson Blower	1
3	90316A194 (McMaster-Carr)	18-8 SS Hex Washer Head Slotted Machine Screw 8-32 Thread, 1/2" Length	4
4	603-00591-01	SX - Blow Tube	1
5	600-00975-01	Foam Filter Bag	1
6	800-00038-01	3 inch hose clamp	2



Blower Mounting Assembly

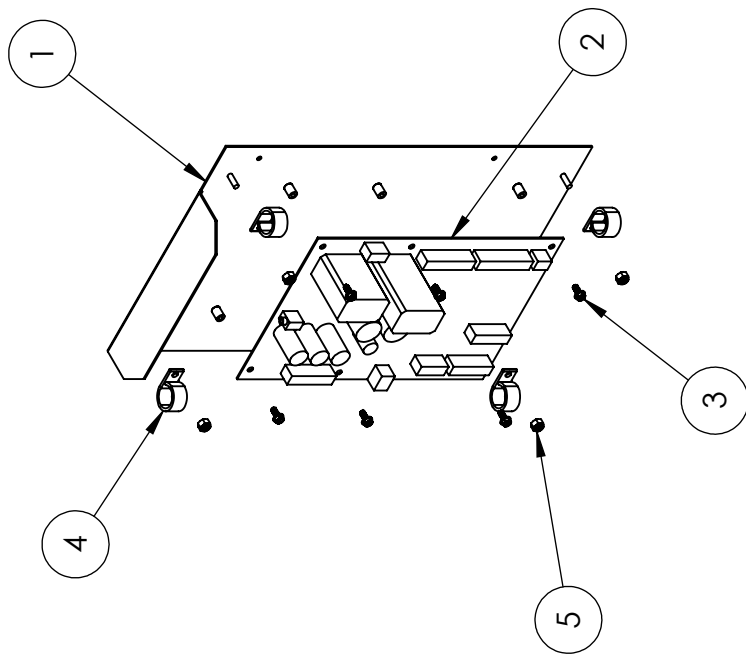
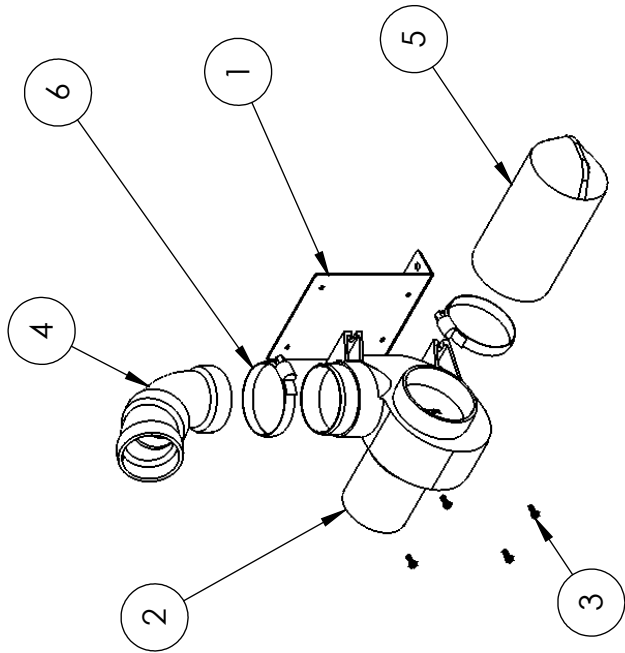

ITEM NO.	PART NUMBER	DESCRIPTION	QTY.
1	600-00513-01	RIO - Mounting Plate Chassis	1
2	500-00040-01	RIO PCB	1
3	90316A192	18-8 SS Hex Washer Head Slotted Machine Screw 8-32 Thread, 3/8" Length	6
4	7572K16 (McMaster-Carr)	Cable Clamp 3/4", Screw Mount	4
5	91831A009	18-8 Stainless Steel Nylon-insert Hex Locknut 8-32 Thread Size, 1 1/32" Width, 15/64" Height	4



RIO Hardware Assembly

ITEM NO.	PART NUMBER	DESCRIPTION	QTY.
1	603-00590-01	Control Panel Dash Plastic	1
2	SnoMotion Keypad Assy	SnoMotion Keypad Assy	1
3	96075A139 (McMaster-Carr)	Alloy STL Pin-in-Torx Button Socket Cap Screw 8-32 Thread, 1/2" Length, Black	3
4	600-00912-01	SX - Dash Speaker Grille (2)	2
5	95638A194	Tamper-Resistant Screw for Sheet Metal Pin-in-Torx, 18-8 SS, Button Head, NO.8 Size, 1/2" L, Black	10
6	600-00717-01	SX - Hood Scoop Grille	1
7	500-00116-01	SX - 36CM ROB LED "Great Wall" Rope	2
8	600-00633-01	LED Clip (Short)	4
9	600-00570-01	LED Clip	4
10	96075A115 (McMaster-Carr)	Alloy STL Pin-in-Torx Button Socket Cap Screw 6-32 Thread, 1/2" Length, Black	8
11	606-00756-01	Control Panel Center Decal	1
12	606-00757-01	Control Panel Side Decal	1

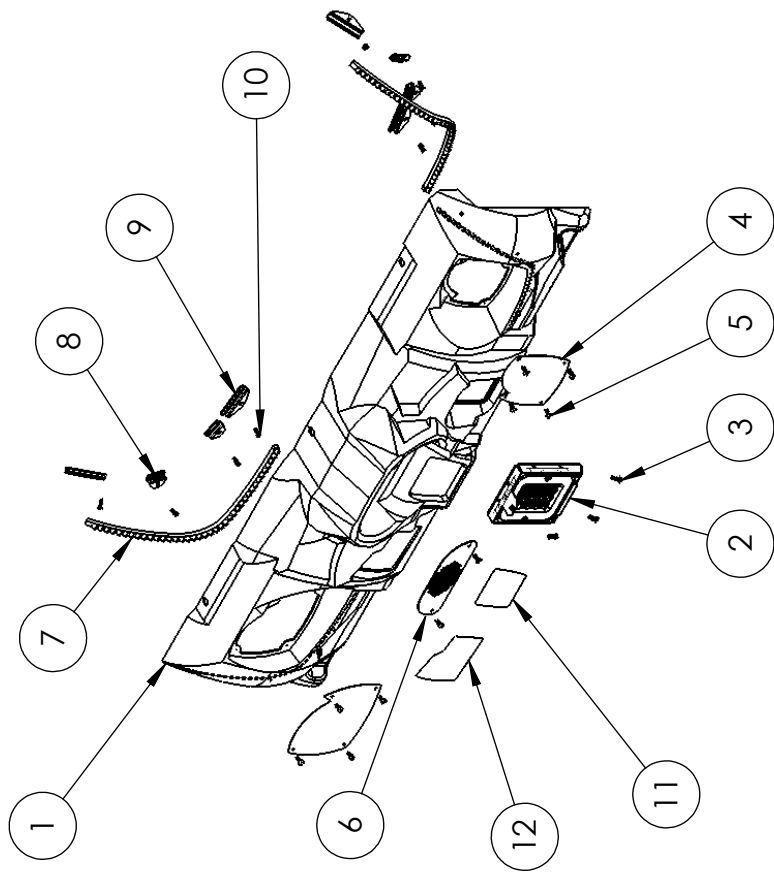

SnoMotion Dash Assembly

ITEM NO.	PART NUMBER	DESCRIPTION	QTY.
1	600-00948-01	Keypad Mounting Bracket	1
2	500-00074-01	SX - 45CM RGB LED Weatherproof Strip Tape	1
3	2-1-14-00-00-000	Keypad (pay phone style)	1
4	91771A108 (McMaster-Carr)	18-8 SS Flat Head Phillips Machine Screw 4-40 Thread, 3/8" Length	4
5	603-00557-01	SX - Keypad Glow	1
6	91772A151 (McMaster-Carr)	18-8 SS Pan Head Phillips Machine Screw 6-32 Thread, 3/4" Length	2

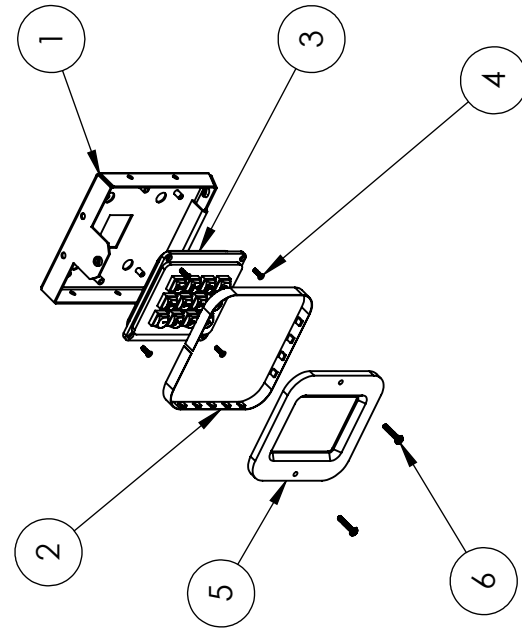

SnoMotion Keypad Assy

ITEM NO.	PART NUMBER	DESCRIPTION	QTY.
1	601-00037-01	42" LCD Frame Assy	1
2	Foam Tape	Black: 1/4"W x 1/8"T x 2"L	2
3	600-00073-01	42" LCD Display Glass (Tempered)	1
4	809-00004-01	42" HD Monitor	1
5	90631A411 (McMaster-Carr)	Znc-Plt'd Grade 2 STL Nylon-Insert Hex Locknut 10-32 Thread Size, 3/8" Width, 15/64" Height	6

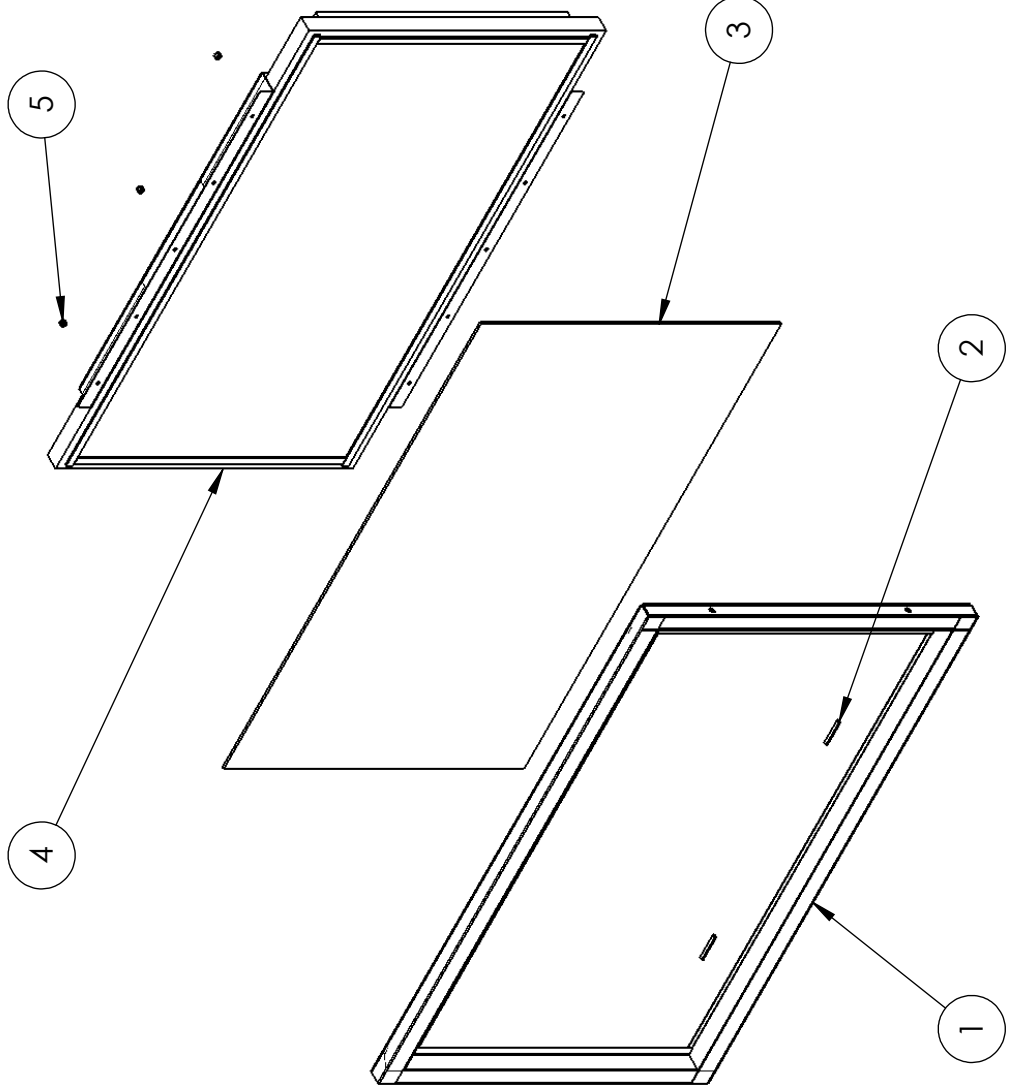

SnoMotion LCD Assembly

ITEM NO.	PART NUMBER	DESCRIPTION	QTY.
1	608-00157-01	SX Motion - T-Base Welded Platform	1
2	Faultless-127-2 12R	Faultless Swivel Plate Caster (Series 100) - 2.5" Wheel Diameter, 1 1/8" Tread Width, Plain Bearing	3
3	LW (.25 in)	Split Lock Washer, 1/4" Screw	12
4	92865A540	Grade 5 Zinc-Plated Steel Hex Head Cap Screw 1/4"-20 Thread, 3/4" Long, Fully Threaded	12
5	49-3043-00 (Happ)	Leg Leveler #1/2-13 Thread, 4" Long, Fully Threaded	4
6	50-2664-22 (Happ)	SX Pivot Assy	1
7	LW (.50)	Split Lock Washer, 1/2" Screw	4
8	92865A712	Grade 5 Zinc-Plated Steel Hex Head Cap Screw 1/2"-13 Thread, 1" Long, Fully Threaded	4
9	600-00253-01	Blind Mate Bracket - Male	1
10	213973-1	Blind Mate Housing (Male): 5mm (.197") Centerline, 600 V, 14 A max. (AMP)	1
11	213283-2	Pin & Socket Hardware Kit, High Durability Drawer Connector, M4 Thread (AMP)	2
12	93825A120	Class 6 Znc-Pltd Steel Hex Nut W/Tooth Washer M4 Screw Sz. .7mm Pitch, 7mm Width, 3.2mm Height	2
13	90675A029 (McMaster-Carr)	Znc-Pltd Stl Machine Screw Nut W/Tooth Washer 1/4"-20 Thrd Sz. 7/16" Nut Width, 3/16" Nut Height	2
14	603-00019-01	T-Base Corner Guard	4
15	600-01007-01	SX Motion - T-Base Edge Bracket Long	2
16	600-01006-01	SX Motion - T-Base Edge Bracket Short	4
17	96075A139 (McMaster-Carr)	Alloy STL Pin-in-Torx Button Socket Cap Screw 8-32 Thread, 1/2" Length, Black	28
18	600-00984-01	Tread Plate - Platform	2
19	820-00005-00	Pedestal Seat Lamp	2
20	600-00020-01	T-Base Plexi	1
21	90316A194 (McMaster-Carr)	18-8 SS Hex Washer Head Slotted Machine Screw 8-32 Thread, 1/2" Length	9
22	606-00783-01	T-Base Caution Decal (small)	4

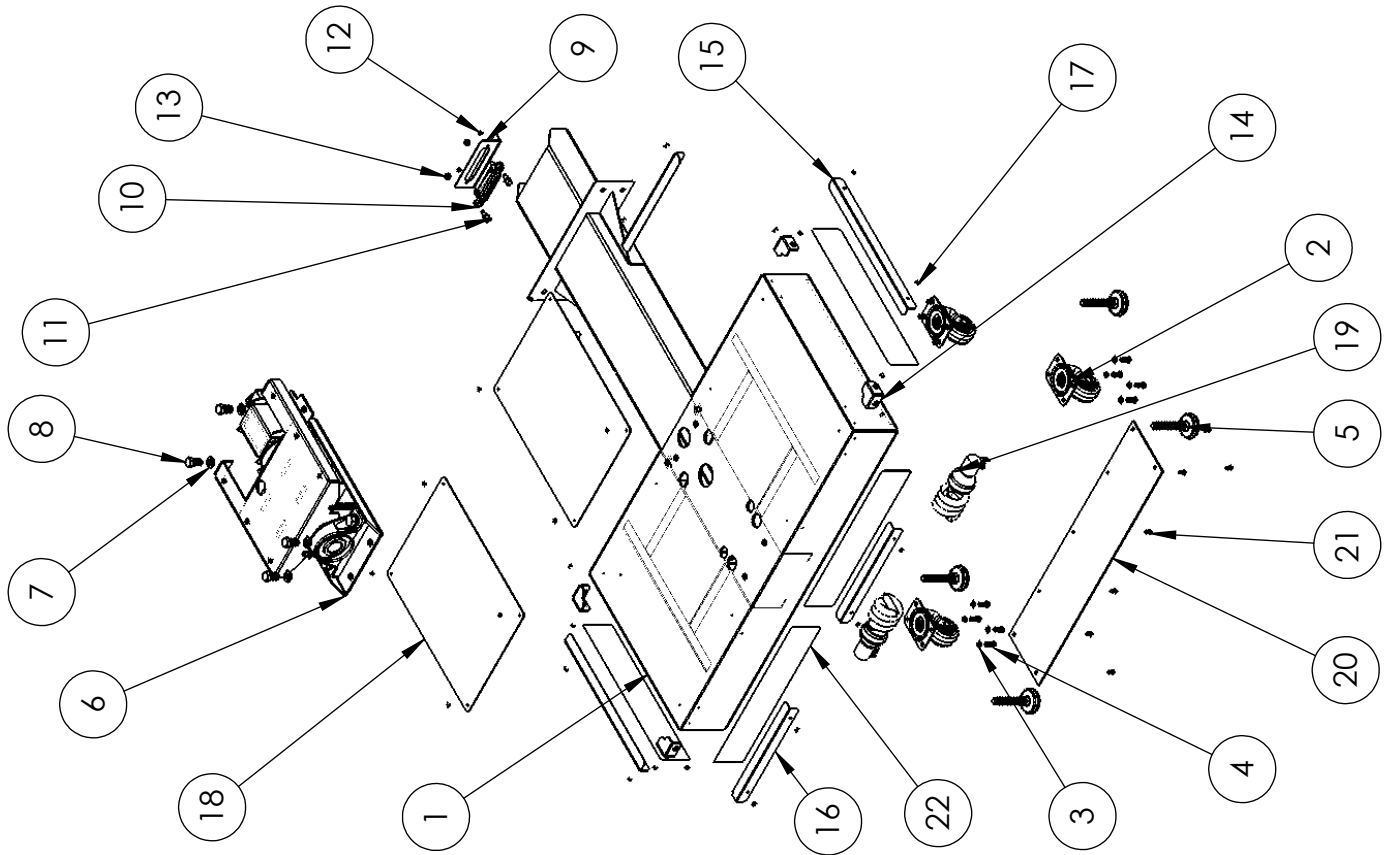

SnoBike T-Base Assembly

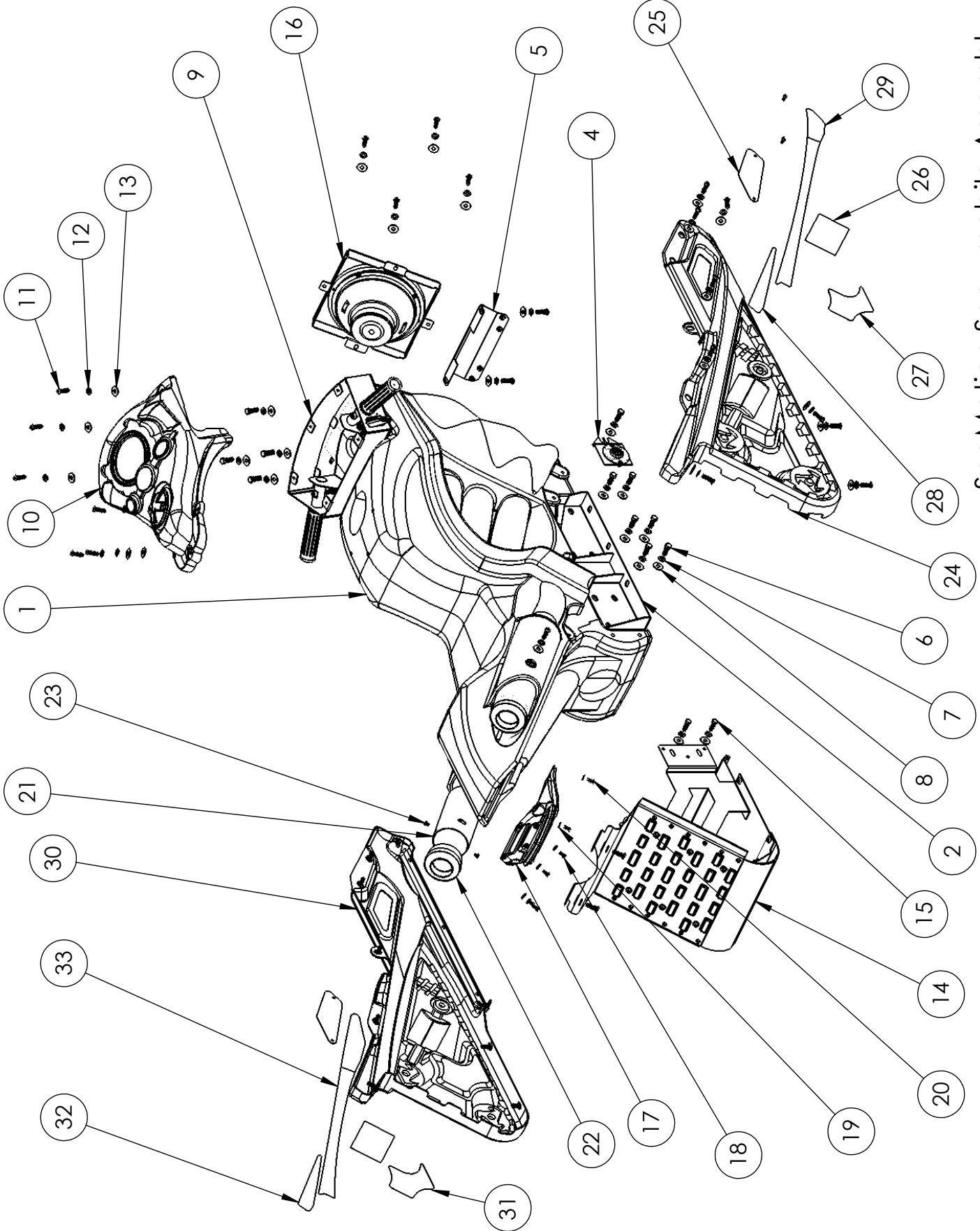

SnoMotion Snowmobile Assembly
(BOM on next page)

SnoMotion Snowmobile Assembly BOM

ITEM NO.	PART NUMBER	DESCRIPTION	QTY.
1	603-00602-01	Rotomolded Snowmobile	1
2	602-00002-00	Bike Mounting Bracket - Right	1
3	602-00001-00	Bike Mounting Bracket - Left	1
4	SnoMotion Puck Light Assembly	SnoMotion Puck Light Assembly	2
5	600-00942-01	Front Vacform Bracket	1
6	92865A583 (McMaster-Carr)	Grade 5 Zinc-Plated Steel Hex Head Cap Screw 5/16"-18 Thread, 1" Long, Fully Threaded	18
7	LW (.313 in)	Split Lock Washer, 5/16" Screw	18
8	FW (.313 in)	Flat Washer, 5/16" Screw	18
9	96-1301-00	SnoMotion Handlebar Assembly	1
10	SnoMotion Fairing Assembly	SnoMotion Fairing Assembly	1
11	96075A223 (McMaster-Carr)	Alloy STL Pin-in-Torx Button Socket Cap Screw 1/4"-20 Thread, 1" Length, Black	32
12	LW (.25 in)	Split Lock Washer, 1/4" Screw	38
13	FW (.25 in)	Flat Washer, 1/4" Screw, Black	38
14	SnoMotion Track Light Assembly	SnoMotion Track Light Assembly	1
15	92865A542 (McMaster-Carr)	Grade 5 Zinc-Plated Steel Hex Head Cap Screw 1/4"-20 Thread, 1" Long, Fully Threaded	6
16	SnoMotion Radiator Woofer Assembly	SnoMotion Radiator Woofer Assembly	1
17	SnoMotion Tailglow Assembly	SnoMotion Tailglow Assembly	1
18	96075A139 (McMaster-Carr)	Alloy STL Pin-in-Torx Button Socket Cap Screw 8-32 Thread, 1/2" Length, Black	4
19	FW (.164)	Flat Washer, #8 Screw, Black	6
20	TP-Torx-SMS-8x.50	Tamper-Resistant Screw for Sheet Metal Pin-in-Torx, 18-8 SS, Button Head, NO.8 Size, 1/2" L, Black	6
21	608-00154-01	SnoMotion Tailpipe	2
22	Exhaust Tip Assembly	Exhaust Tip Assembly	2
23	TP-Torx-FH-MS-6-32x.375	18-8 SS Tamper-Resist Flat Head Machine Screw Pin-in-Torx, 6-32 Thread, 3/8" Length, Black	4
24	603-00587-01	SnoMotion Cover Skirt Plastic - Right	1
25	600-00941-01	Side Skirt Grille	2
26	606-00764-01	Shock Decal	2
27	606-00765-01	Right Mech Decal	1
28	606-00762-01	Right Accent Decal	1
29	606-00760-01	Right Frame Decal	1
30	603-00588-01	SnoMotion Cover Skirt Plastic - Left	1
31	606-00766-01	Left Mech Decal	1
32	606-00763-01	Left Accent Decal	1
33	606-00761-01	Left Frame Decal	1

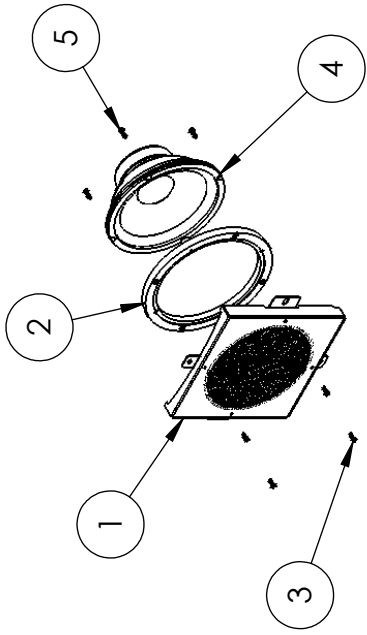

ITEM NO.	PART NUMBER	DESCRIPTION	QTY.
1	600-00958-01	Radiator - 8" Woofer	1
2	601-00592-01	8" Woofer Panel - Spacer	1
3	96075A139 (McMaster-Carr)	Alloy STL Pin-in-Torx Button Socket Cap Screw 8-32 Thread, 1/2" Length, Black	4
4	2-1-18-00-00-000	8" Woofer, 4 Ohm, Poly-Mica Cone	1
5	90316A196 (McMaster-Carr)	18-8 SS Hex Washer Head Slotted Machine Screw 8-32 Thread, 5/8" Length	4

Snomotion Radiator Woofer Assembly

ITEM NO.	PART NUMBER	DESCRIPTION	QTY.
1	600-00939-01	Puck Light Bracket	1
2	500-00084-02	Blue LED Spotlight PCB	1
3	90272A191 (McMaster-Carr)	Zinc-Pltd STL Pan Head Phillips Machine Screw 8-32 Thread, 5/16" Length	2
4	90631A009 (McMaster-Carr)	Znc-Pltd Grade 2 STL Nylon-Insert Hex Locknut 8-32 Thread Size, 1 1/32" Width, 15/64" Height	2

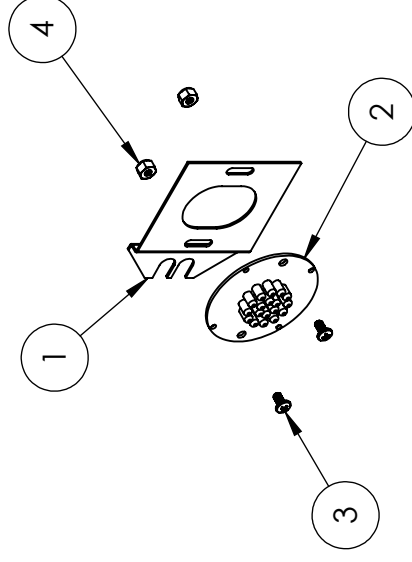

Snomotion Puck Light Assembly

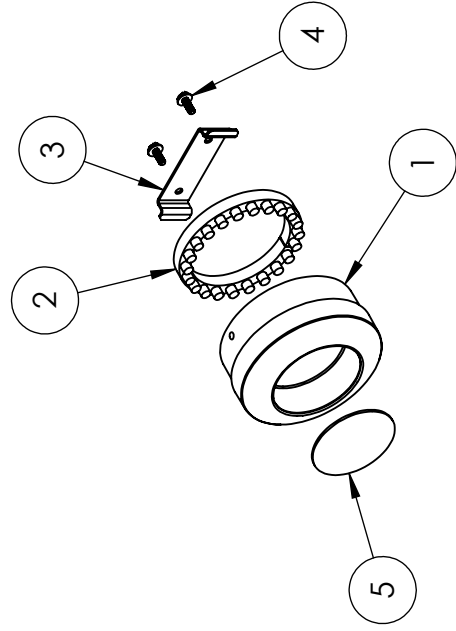

ITEM NO.	PART NUMBER	DESCRIPTION	QTY.
1	603-00005-01	Tail Pipe Cap	1
2	500-00111-01	SX - 21CM ROB LED "Great Wall" Rope	1
3	600-00951-01	Exhaust Cap Bracket	1
4	90316A165 (McMaster-Carr)	18-8 SS Hex Washer Head Slotted Machine Screw 6-32 Thread, 3/8" Length	2
5	606-00773-01	Tail Cap Decal	1

Exhaust Tip Assembly

ITEM NO.	PART NUMBER	DESCRIPTION	QTY.
1	600-00937-01	SnoMotion Track Plate	1
2	603-00543-01	5-Hole Tread Plastic	3
3	603-00544-01	4-Hole Tread Plastic	3
4	500-00071-01	SX - 24CM Blue LED "Great Wall" Rope	6
5	96075A139 (McMaster-Carr)	Alloy STL Pin-in-Torx Button Socket Cap Screw 8-32 Thread, 1/2" Length, Black	12
6	601-00595-01	SnoMotion - Tread Light Mount Panel	1
7	TP-Torx-MS-.25-20x1.75	Alloy STL Pin-in-Torx Button Socket Cap Screw 1/4"-20 Thread, 1.75" Length, Black	6
8	LW (.25 in)	Split Lock Washer, 1/4" Screw	8
9	600-00936-01	Track Frame Weldment	1
10	606-00614-01	Track Plate Decal	1
11	96075A219 (McMaster-Carr)	Alloy STL Pin-in-Torx Button Socket Cap Screw 1/4"-20 Thread, 3/4" Length	2

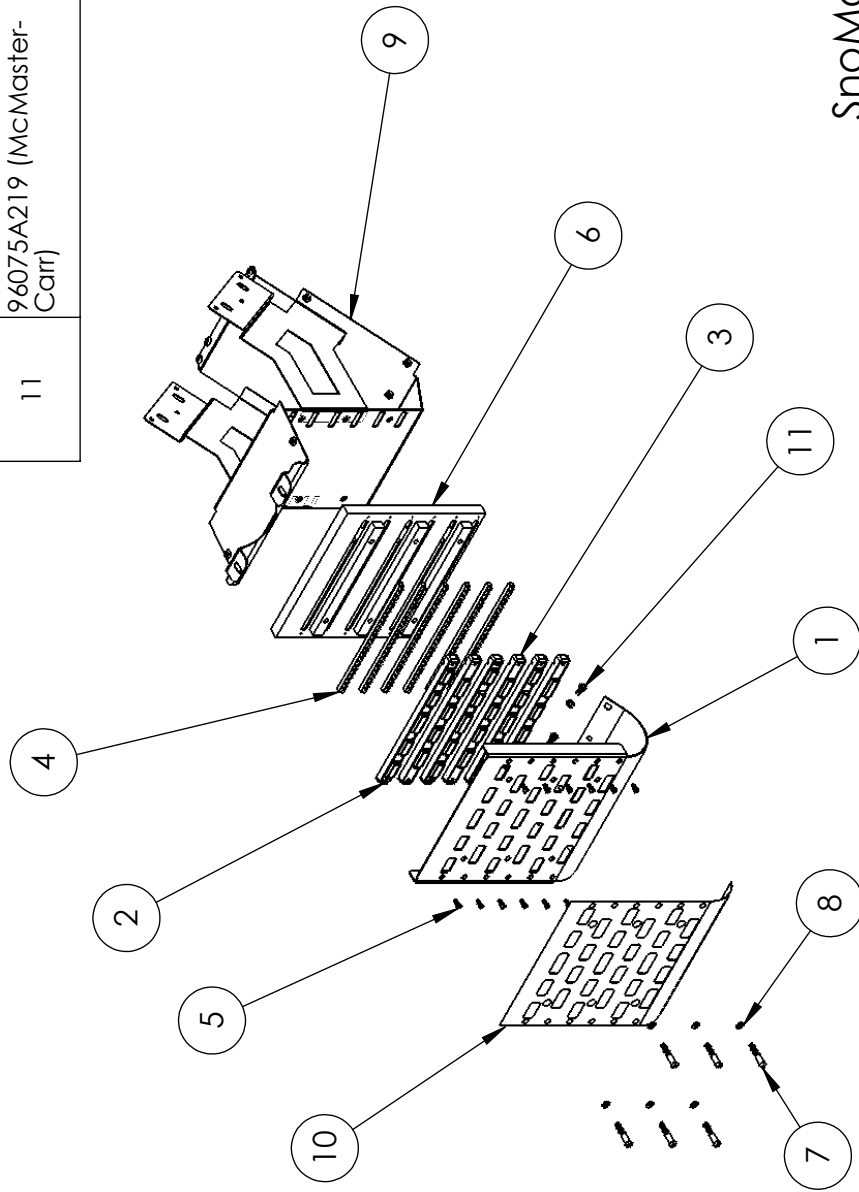

SnoMotion Track Light Assembly

ITEM NO.	PART NUMBER	DESCRIPTION	QTY.
1	600-00943-01	SnoMotion - Tail Light Bracket	1
2	500-00113-01	15CM RGB LED Weatherproof Strip Tape	1
3	603-00594-01	SnoMotion - Taillight Top/Bottom Plate	2
4	603-00595-01	SnoMotion - Taillight Middle Plate	1
5	603-00589-01	Taillight Housing Plastic	1
6	96075A139 (McMaster-Carr)	Alloy STL Pin-in-Torx Button Socket Cap Screw 8-32 Thread, 1/2" Length, Black	2
7	FW (.164)	Flat Washer, #8 Screw, Black	4
8	96075A155 (McMaster-Carr)	Alloy STL Pin-in-Torx Button Socket Cap Screw 8-32 Thread, 1-1/2" Length, Black	2
9	606-00767-01	Tail Light Cover Decal	1

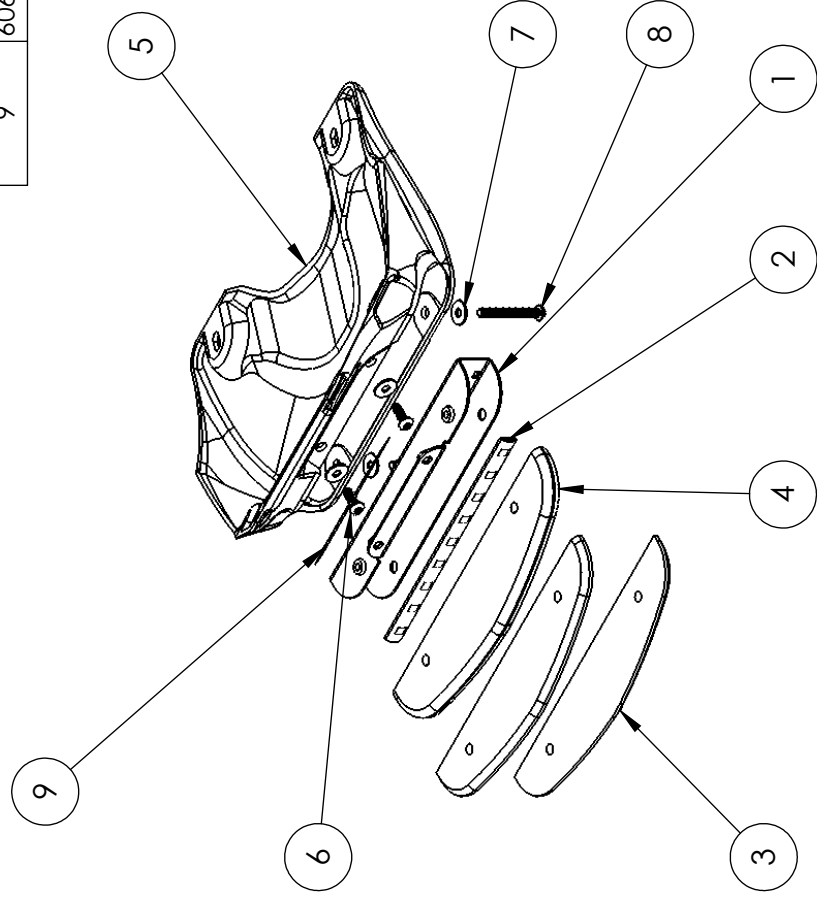

SnoMotion Taillight Assembly

ITEM NO.	PART NUMBER	DESCRIPTION	QTY.
1	603-00605-01	SnoMotion Fairing	1
2	702-00036-00	Blue X-Button/Gold sw/6V LED	1
3	702-00040-00	Small Oval Button/White w "VIEW"/Gold sw/6V LED	1
4	702-00039-00	Small Oval Button/Red w "SnoBall"/Gold sw/6V LED	1
5	606-00758-01	Fairing Speedo Decal	1
6	606-00759-01	Fairing Button Decal	1
7	606-00772-01	Fairing Right Decal	1
8	606-00771-01	Fairing Left Decal	1

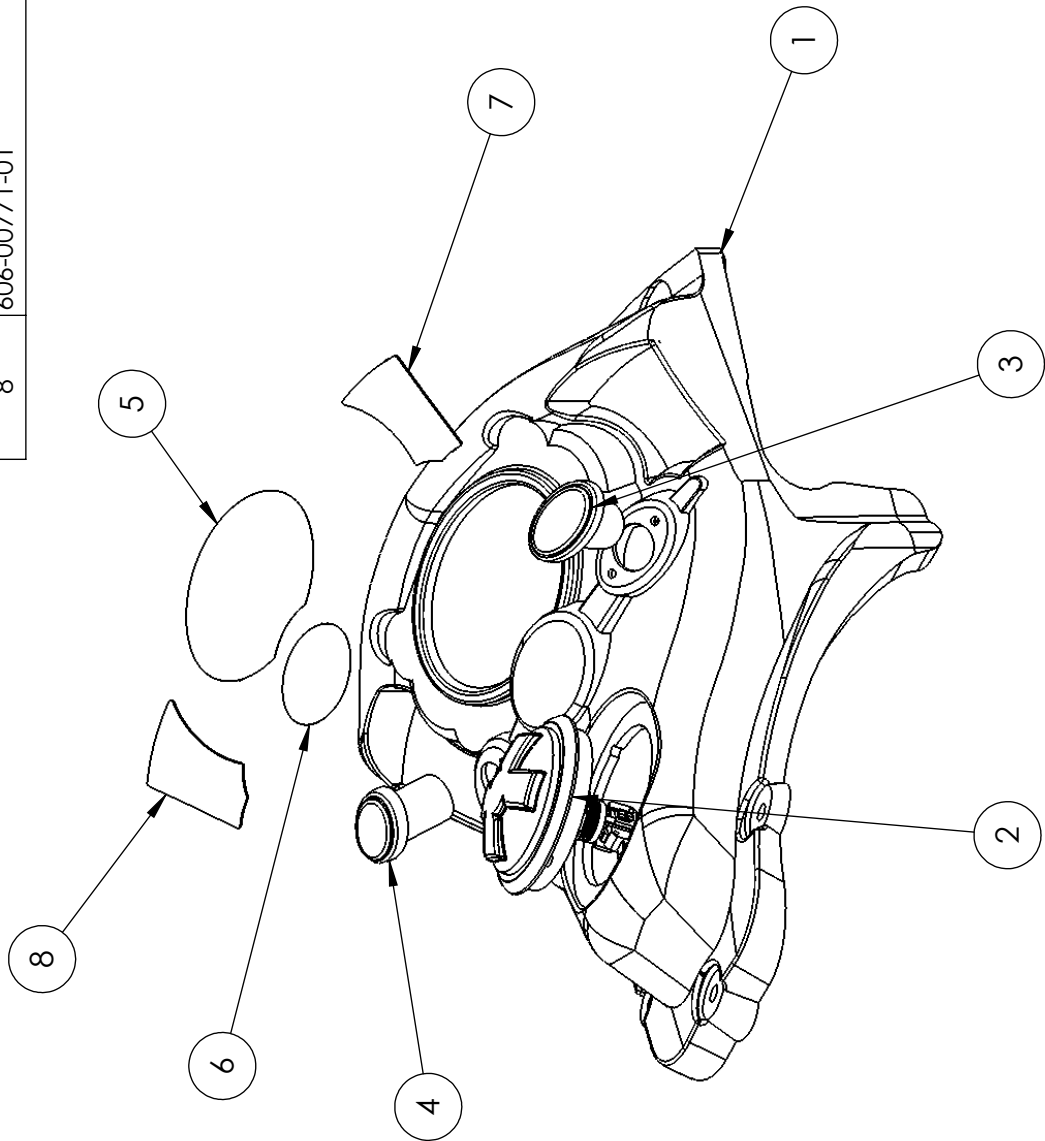

SnoMotion Fairing Assembly



SX 42" Marquee Assembly
(BOM on next page)

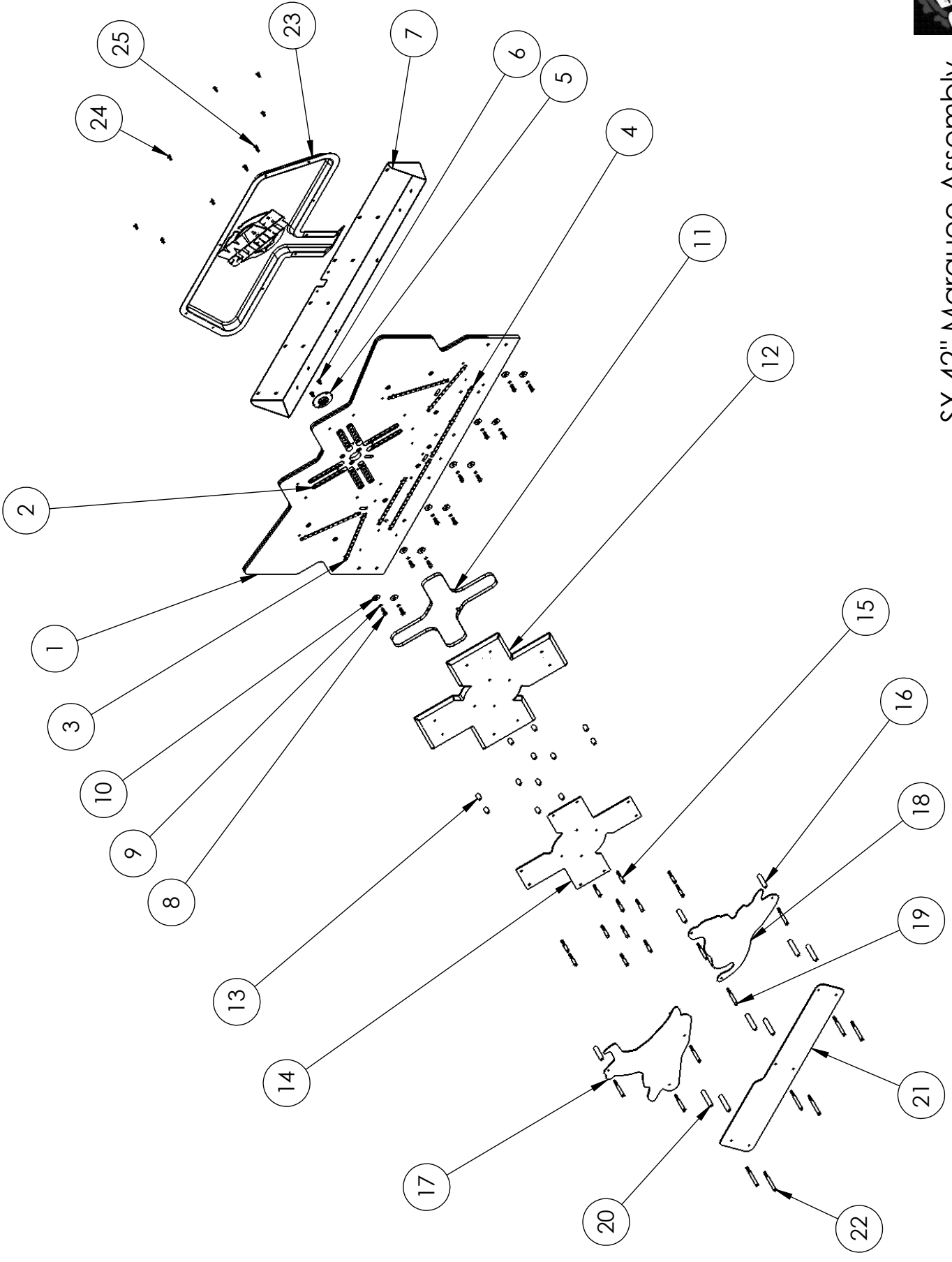

SX 42" Marquee Assembly BOM

ITEM NO.	PART NUMBER	DESCRIPTION	QTY.
1	601-00601-01	SX - 42" Marquee Back Board	1
2	500-00093-01	10CM White LED Strip Tape	8
3	500-00115-01	20CM White LED Weatherproof Strip Tape	5
4	500-00112-01	30CM White LED Weatherproof Strip Tape	2
5	500-00064-01	White LED PCB - Black Face	1
6	90316A829 (McMaster-Carr)	18-8 SS Hex Washer Head Slotted Machine Screw 10-32 Thread, 1/2" Length	2
7	600-00950-01	SX-42 Marquee Board Bracket	1
8	96075A219 (McMaster-Carr)	Alloy STL Pin-in-Torx Button Socket Cap Screw 1/4"-20 Thread, 3/4" Length	12
9	LW (.25 in)	Split Lock Washer, 1/4" Screw	12
10	FW (.25 in)	Flat Washer, 1/4" Screw, Black	12
11	500-00091-01	130CM Blue LED Strip Tape	1
12	603-00581-01	SX - Marquee Acrylic "X"	1
13	600-00997-01	0.75" SLEEVE	12
14	606-00744-01	SX - Marquee Center PETG	1
15	BH-Socket-MS-10-32x1.75	18-8 SS Button Head Socket Cap Screw 10-32 Thread, 1-3/4" Length, Black	12
16	600-00954-01	2" SLEEVE	6
17	606-00746-01	SX - Snowmobile Left PETG	1
18	606-00747-01	SX - Snowmobile Right PETG	1
19	BH-Socket-MS-10-32x2.50	18-8 SS Button Head Socket Cap Screw 10-32 Thread, 2-1/2" Length, Black	6
20	600-01001-01	2.50" SLEEVE	6
21	606-00745-01	SX - Marquee Snocross PETG	1
22	BH-Socket-MS-10-32x3	18-8 SS Button Head Socket Cap Screw 10-32 Thread, 3" Length, Black	6
23	603-00598-01	SX - Marquee Back Cover	1
24	96075A187 (McMaster-Carr)	Alloy STL Pin-in-Torx Button Socket Cap Screw 10-32 Thread, 1/2" Length, Black	7
25	96075A191 (McMaster-Carr)	Alloy STL Pin-in-Torx Button Socket Cap Screw 10-32 Thread, 3/4" Length, Black	2

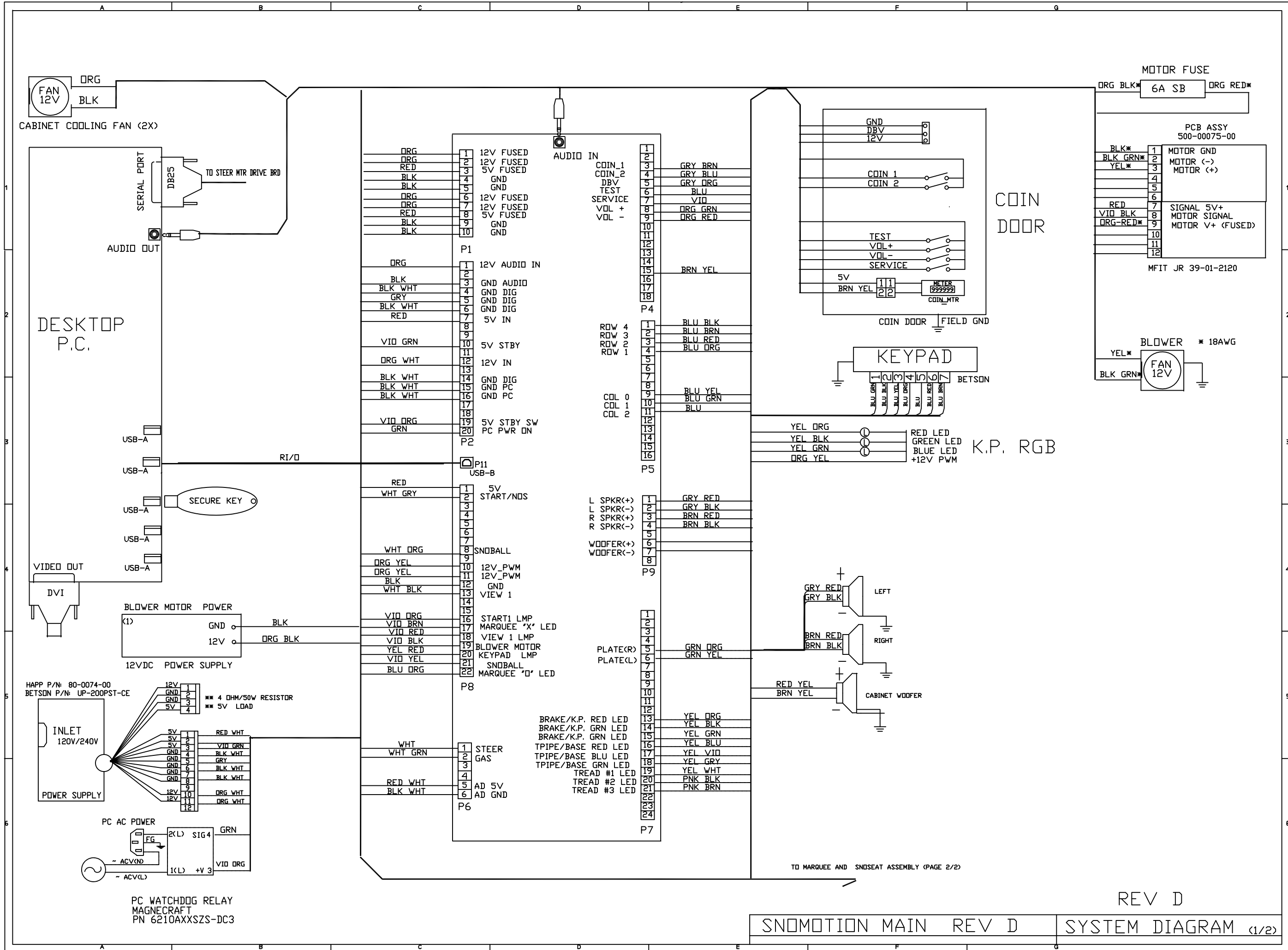

REV D

30 PDS. BLIND MATE CONN.

1	1	BLK
2	2	BLK WHT
3	3	RED WHT
4	4	WHT GRN
5	5	WHT
6	6	WHT BLK
7	7	WHT GRY
8	8	WHT ORG
9	9	VID RED
10	10	VID ORG
11	11	VID YEL
12	12	GRN ORG
13	13	GRN YEL
14	14	YEL BLU
15	15	YEL VID
16	16	YEL GRY
17	17	YEL ORG
18	18	YEL BLK
19	19	YEL GRN
20	20	YEL WHT
21	21	PNK BLK
22	22	PNK BRN
23	23	GRNYEL(18AWG)
24	24	WHT BLK(18AWG)
25	25	BLK WHT(18AWG)
26	26	ORG YEL(18AWG)
27	27	RED YEL(18AWG)
28	28	BRN YEL(18AWG)
29	29	RED (2X)
30	30	RED WHT

EARTH GROUND
 ~ AC NEUTRAL
 ~ AC VOLTAGE

WARNING:
 DANGEROUS HIGH VOLTAGE PRESENT
 PEDESTAL
 INTERFACE

FROM MAIN CABINET

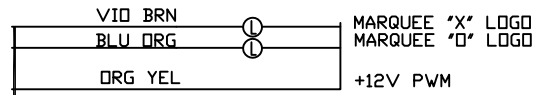

MARQUEE

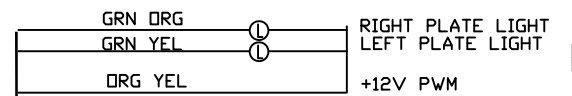
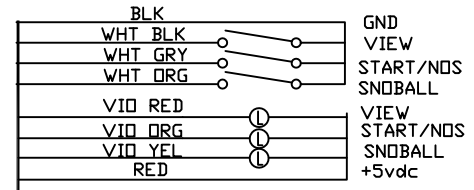
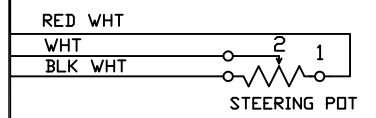
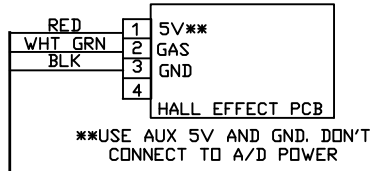
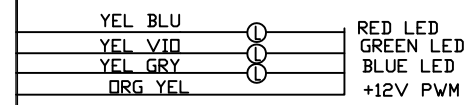
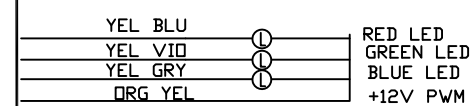

PLATE PUCK LIGHT



TAIL PIPE(R) RGB LED



TAIL PIPE(L) RGB LED

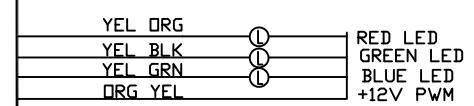

BRAKE RGB LED

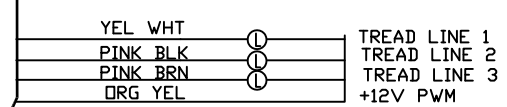

TREAD LIGHTS

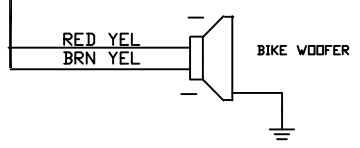
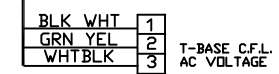

For Parts or Service contact your local Distributor or:

Betson Enterprises

303 Paterson Plank Road

Carlstadt, New Jersey

Main Phone: (201) 438-1300

Toll Free Phone: (800) 524-2343

Part Phone: (800) 828-2048

CAUTION:

- The specifications of this product are subject to change without notice for reasons such as performance.
- The content of this game, its main devices and design are protected under each federal law concerning patent, copyright and other intellectual properties.
- Unauthorized reproduction of this document or any of its contents is strictly forbidden.
- Visit www.Rawthrills.com for the latest technical information.